

JZ20-T10/JZ20-J-T10

- 6 Digital Inputs including 2 HSC, 4 Transistor Outputs

JZ20-T18/JZ20-J-T18

- 6 Digital Inputs including 2 HSC, 2 Analog/Digital Inputs, 2 Analog Inputs, 8 Transistor Outputs

JZ20-J-T20HS

- 6 Digital Inputs including 3 HSC/Shaft-encoder, 2 Analog/Digital Inputs, 2 Analog Inputs, 10 Transistor Outputs

General Description



The products listed above are micro-PLC+HMIs, rugged programmable logic controllers that comprise built-in operating panels.

Detailed Installation Guides containing the I/O wiring diagrams for these models, technical specifications, and additional documentation are located in the Technical Library in the Unitronics website:

<https://unitronicsplc.com/support-technical-library/>

Alert Symbols and General Restrictions

When any of the following symbols appear, read the associated information carefully.

Symbol	Meaning	Description
	Danger	The identified danger causes physical and property damage.
	Warning	The identified danger could cause physical and property damage.
<i>Caution</i>	Caution	Use caution.

- Before using this product, the user must read and understand this document.
- All examples and diagrams are intended to aid understanding, and do not guarantee operation. Unitronics accepts no responsibility for actual use of this product based on these examples.
- Please dispose of this product according to local and national standards and regulations.
- Only qualified service personnel should open this device or carry out repairs.

	▪ Failure to comply with appropriate safety guidelines can cause severe injury or property damage.
--	--

	▪ Do not attempt to use this device with parameters that exceed permissible levels. ▪ To avoid damaging the system, do not connect/disconnect the device when power is on.
--	---

Environmental Considerations

- Do not install in areas with: excessive or conductive dust, corrosive or flammable gas, moisture or rain, excessive heat, regular impact shocks or excessive vibration, in accordance with the standards given in the product's technical specification sheet.
 - Do not place in water or let water leak onto the unit.
 - Do not allow debris to fall inside the unit during installation.
- | | |
|--|--|
|  | ▪ Ventilation: 10mm space required between controller's top/bottom edges & enclosure walls.
▪ Install at maximum distance from high-voltage cables and power equipment. |
|--|--|

Mounting

Note that figures are for illustrative purposes only.

Dimensions

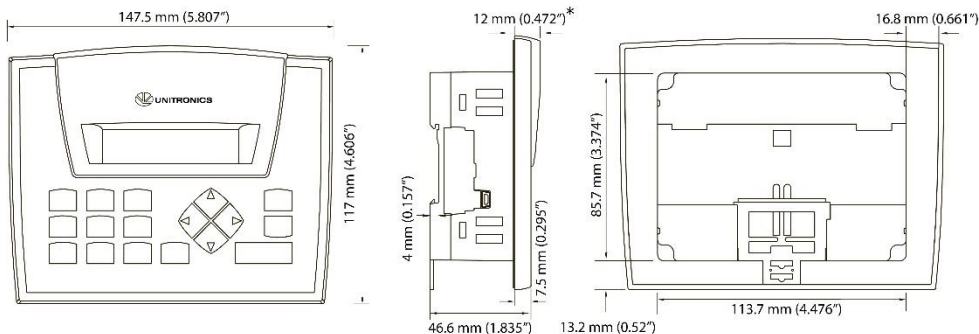

* * Note that for JZ20-J modules those dimensions are 7.5 mm (0.295").

Model	Cut-out	View area
JZ20-xxx\JZ20-J-xxx	117 x 89mm (4.606"x 3.504")	66 x 19.2mm (2.598"x 0.755")

Add-on modules-

Available by separate order for communication and cloning.

Integral USB Port

This may be used for programming purposes.

Note: the USB port and an Add-on module cannot be physically connected at the same time.

Add-on: during installation

Installing an Add-on module requires sufficient clearance space

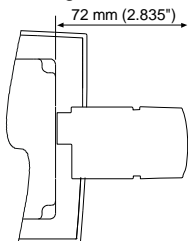

Add-on: after installation

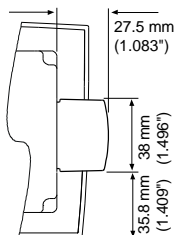

USB Port

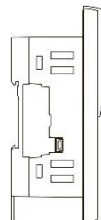

DIN-rail mounting

Snap PLC onto the DIN rail

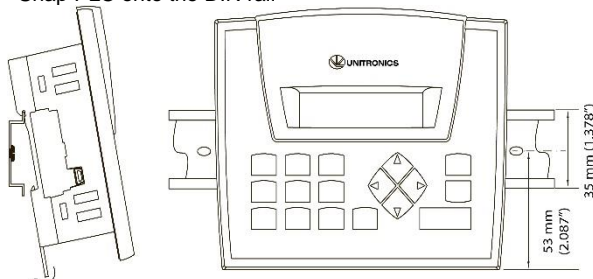

Panel mounting

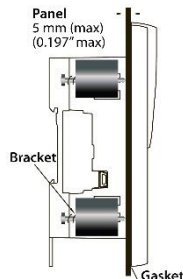

Note: Removing the unit requires clearance space. Recommendation: approximately 40mm (1.58")

Wiring



- Do not touch live wires.



- This equipment is designed to operate only in SELV/PELV/Class 2/Limited Power environments.
- All power supplies in the system must include double insulation. Power supply outputs must be rated as SELV/PELV/Class 2/Limited Power.
- Do not connect either the 'Neutral' or 'Line' signal of the 110/220VAC to device's 0V pin.
- All wiring activities should be performed while power is OFF.
- Use over-current protection, such as a fuse or circuit breaker, to avoid excessive currents into the power supply connection point.
- Unused points should not be connected (unless otherwise specified). Ignoring this directive may damage the device.
- Double-check all wiring before turning on the power supply.

Caution

- To avoid damaging the wire, do not exceed a maximum torque of:
 - Controllers offering a terminal block with pitch of 5mm: 0.5 N·m (5 kgf·cm).
 - Controllers offering a terminal block with pitch of 3.81mm f 0.2 N·m (2 kgf·cm).
- Do not use tin, solder, or any substance on stripped wire that might cause the wire strand to break.
- Install at maximum distance from high-voltage cables and power equipment.

Wiring Procedure

Use crimp terminals for wiring;

- Controllers offering a terminal block with pitch of 5mm: 26-12 AWG wire (0.13 mm² –3.31 mm²).
 - Controllers offering a terminal block with pitch of 3.81mm: 26-16 AWG wire (0.13 mm² – 1.31 mm²).
1. Strip the wire to a length of 7±0.5mm (0.270–0.300").
 2. Unscrew the terminal to its widest position before inserting a wire.
 3. Insert the wire completely into the terminal to ensure a proper connection.
 4. Tighten enough to keep the wire from pulling free.

Wiring Guidelines

- Use separate wiring ducts for each of the following groups:
 - Group 1: Low voltage I/O and supply lines, communication lines.
 - Group 2: High voltage Lines, Low voltage noisy lines like motor driver outputs.
 Separate these groups by at least 10cm (4"). If this is not possible, cross the ducts at a 90° angle.
- For proper system operation, all 0V points in the system should be connected to the system 0V supply rail.
- Product-specific documentation must be fully read and understood before performing any wiring.

Allow for voltage drop and noise interference with input lines used over an extended distance. Use wire that is properly sized for the load.

Earthing the product

To maximize system performance, avoid electromagnetic interference as follows:

- Use a metal cabinet.
- Connect the 0V and functional ground points (if exist) directly to the earth ground of the system.
- Use the shortest, less than 1m (3.3 ft.) and thickest, 2.08mm² (14AWG) min, wires possible.

UL Compliance

The following section is relevant to Unitronics' products that are listed with the UL.

The following models: JZ20-R10, JZ20-J-R10, JZ20-R16, JZ20-J-R16, JZ20-J-R16HS, JZ20-R31, JZ20-J-R31, JZ20-J-R31L, JZ20-T10, JZ20-J-T10, JZ20-T18, JZ20-J-T18, JZ20-J-T20HS, JZ20-T40, JZ20-J-T40, JZ20-UA24, JZ20-J-UA24, JZ20-UN20, JZ20-J-UN20, JZ20-J-ZK2.

are UL listed for Ordinary Location.

UL Ordinary Location

In order to meet the UL ordinary location standard, panel-mount this device on the flat surface of Type 1 or 4 X enclosures

Panel-Mounting

For programmable controllers that can be mounted also on panel, in order to meet the UL Haz Loc standard, panel-mount this device on the flat surface of Type 1 or Type 4X enclosures.

Communication and Removable Memory Storage

When products comprise either USB communication port, SD card slot, or both, neither the SD card slot nor the USB port are intended to be permanently connected, while the USB port is intended for programming only.

Removing / Replacing the battery

When a product has been installed with a battery, do not remove or replace the battery unless the power has been switched off, or the area is known to be non-hazardous.

Please note that it is recommended to back up all data retained in RAM, in order to avoid losing data when changing the battery while the power is switched off. Date and time information will also need to be reset after the procedure.

UL des zones ordinaires:

Pour respecter la norme UL des zones ordinaires, monter l'appareil sur une surface plane de type de protection 1 ou 4X

Montage de l'écran:

Pour les automates programmables qui peuvent aussi être monté sur l'écran, pour pouvoir être au standard UL, l'écran doit être monté dans un coffret avec une surface plane de type 1 ou de type 4X.

Communication et de stockage amovible de mémoire (carte mémoire)

Produits comprend un port USB de communication, soit un port carte SD ou les deux, ni le port SD, ni le port USB ne sont censés être utilisés en permanence, tandis que l'USB est destiné à la programmation uniquement.

Retrait / Remplacement de la batterie

Lorsqu'un produit a été installé avec une batterie, retirez et remplacez la batterie seulement si l'alimentation est éteinte ou si l'environnement n'est pas dangereux.

Veillez noter qu'il est recommandé de sauvegarder toutes les données conservées dans la RAM, afin d'éviter de perdre des données lors du changement de la batterie lorsque l'alimentation est coupée. Les informations sur la date et l'heure devront également être réinitialisées après la procédure

Inputs

1. All the products comprise I0-I5; these digital inputs are arranged in a single group. Via wiring, the entire group may be set to either pnp or npn.
2. The following information concerns JZ20-T10/JZ20-J-T10 and JZ20-T18/JZ20-J-T18: I0 and I1 can function as high-speed counters or as normal digital inputs.
3. The following information concerns JZ20-J-T20HS:
 - I0, I1, and I4 can function as high-speed counters, as part of a shaft-encoder, or as normal digital inputs.
 - I2, I3, and I5 can function as either counter reset, as part of a shaft-encoder, or as normal digital inputs.
 - If I0, I1, I4 are set as high-speed counters (without reset), I2, I3, I5 can function as normal digital inputs.
4. The following information concerns JZ20-T18/JZ20-J-T18 and JZ20-J-T20HS in addition to I0-I5, these comprise the following:

I6 and I7 may be wired as either digital or analog inputs. These may be wired as either:

 - npn digital inputs
 - pnp digital inputs
 - analog (voltage) inputs

In addition, one input may be wired as a pnp input, while the other is wired as an analog input. Note that if one input is wired as an npn input, the other may not be wired as an analog input.
5. The following information concerns JZ20-T18/JZ20-J-T18 and JZ20-J-T20HS:

AN0 and AN1 are analog (current) inputs.

Digital Inputs, Controller's Power Supply

JZ20-T10/JZ20-J-T10

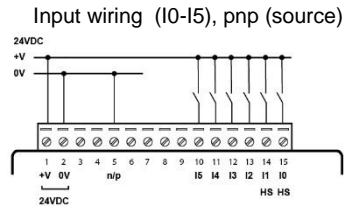
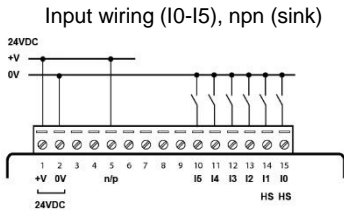

JZ20-T18/JZ20-J-T18

Note: The inputs are arranged in two groups. You can wire one group as npn and the other as pnp, or wire both groups as npn, or as pnp. In either case, the n/p pins **must be connected**.

Input wiring (I0-I7), npn (sink)

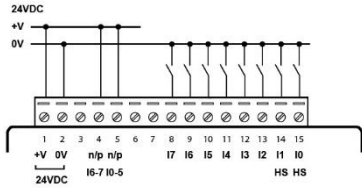

Input wiring (I0-I7), pnp (source)

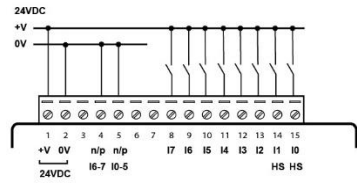

Input wiring (I0-I5), pnp (source), (I6-I7), npn (sink)

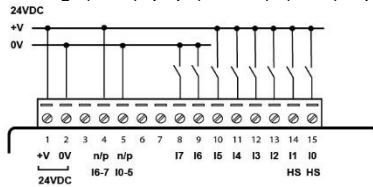

JZ20-J-T20HS

Note: The inputs are arranged in two groups. You can wire one group as npn and the other as pnp, or wire both groups as npn, or as pnp. In either case, the n/p pins **must be connected**.

Input wiring (I0-I7), npn (sink)

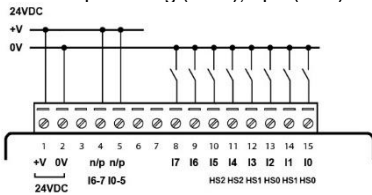

Input wiring (I0-I7), pnp (source)

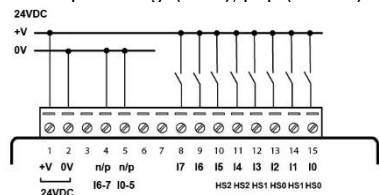

Input wiring (I0-I5), pnp (source), (I6-I7), npn (sink)

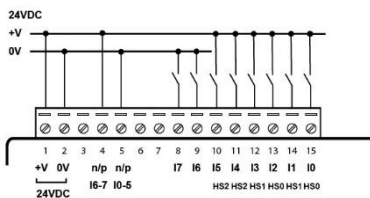

HSC input wiring, npn (sink)

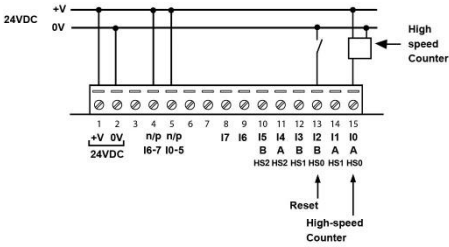

HSC input wiring, pnp (source)

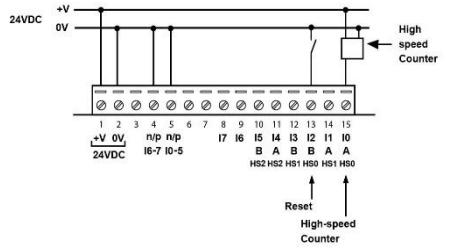

Shaft-encoder wiring, npn (sink)

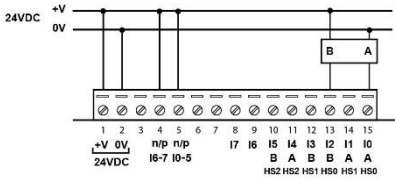

Shaft-encoder wiring, pnp (source)

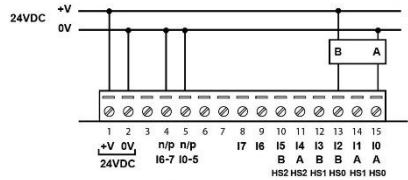

Digital Outputs, Outputs' Power Supply

JZ20-T10/JZ20-J-T10

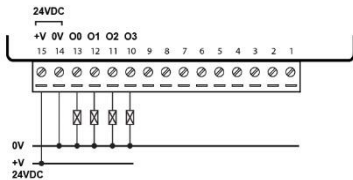

JZ20-T18/JZ20-J-T18

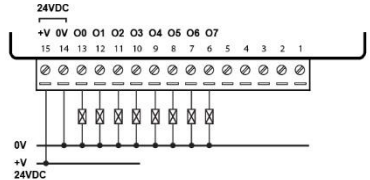

JZ20-J-T20HS

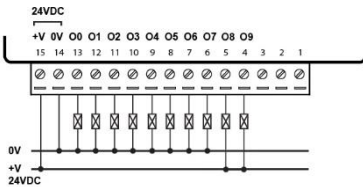

Analog inputs

Note: Shields should be connected at the signal source.

Analog Input wiring, current (JZ20-T18/JZ20-J-T18/JZ20-J-T20HS only)

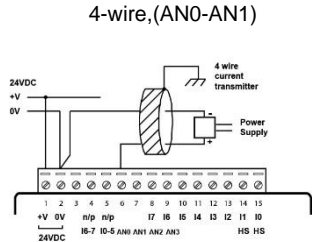
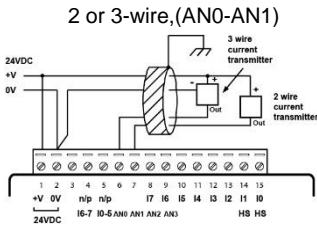

Analog Input wiring, voltage

Note: If either I6 or I7 is wired as an npn digital input, the remaining input may not be wired as an analog input.

JZ20-T18/JZ20-J-T18/JZ20-J-T20HS, (AN2-AN3)

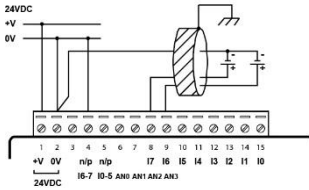

Technical Specifications

Power supply

Input voltage	24VDC	
Permissible range	20.4-28.8VDC with less than 10% ripple	
Current Consumption	See Note 1	
	JZ20-T10/JZ20-J-T10	JZ20-T18/JZ20-J-T18/JZ20-J-T20HS
Max. current consumption	96mA@24VDC	100mA@24VDC
Typical power consumption	1.8W	1.8W

Notes:

- To If you do not use the LCD backlight, subtract 35mA from the maximum current consumption value.

Battery

Back-up	7 years typical at 25°C, battery back-up for RTC and system data, including variable data.
---------	--

Digital Inputs

Number of inputs	JZ20-T10/JZ20-J-T10	JZ20-T18/JZ20-J-T18/JZ20-J-T20HS
	6 (one group) – see Note 2.	8 (two groups) – see Notes 2 & 3
Input type	pnp (source) or npn (sink)	
Galvanic isolation	None	
Nominal input voltage	24VDC	
Input voltage		
pnp (source)	0-5VDC for Logic '0' 17-28.8VDC for Logic '1'	
npn (sink)	17-28.8VDC for Logic '0' 0-5VDC for Logic '1'	
	I0-I5	I6-I7
Input current	3.7mA@24VDC	1.2mA@24VDC
Response time	10mSec typical	20mSec typical
Input cable length	Up to 100 meters, unshielded	
High speed inputs	Specifications below apply when wired as HSC/Shaft-encoder. See Note 4 & 5.	
Resolution	16-bit	
Frequency	10kHz maximum	
Minimum pulse width	40µs	

Notes:

- All products comprise I0-I5; these inputs are arranged in a single group. Via wiring, the entire group may be set to either pnp or npn.
- Only JZ20-T18/JZ20-J-T18 and JZ20-J-T20HS comprises I6 & I7. These may be wired as either digital or analog inputs, as shown in the JZ20-T18/JZ20-J-T18 and JZ20-J-T20HS Micro PLC Installation guide. I6 & I7 may be wired as npn, pnp, or 0-10V analog inputs. I1 input may be wired as pnp, while the other is wired as analog. If I1 input is wired as npn, the other may **not** be wired as analog.
- Only in JZ20-T10/JZ20-J-T10 and JZ20-T18/JZ20-J-T18:
 - I0 and I1 can each function as either a high-speed counter or as a normal digital input.

- When used as a normal digital input, normal input specifications apply.
5. Only in JZ20-J-T20HS:
- I0, I1, and I4 can function as high-speed counters, as part of a shaft-encoder, or as normal digital inputs.
 - I2, I3, and I5 can function as either counter reset, as part of a shaft-encoder, or as normal digital inputs.
 - If I0, I1, I4 are set as high-speed counters (without reset), I2, I3, I5 can function as normal digital inputs.
 - When used as a normal digital input, normal input specifications apply.

Source Digital Outputs

Number of outputs	JZ20-T10/JZ20-J-T10	JZ20-T18/JZ20-J-T18/JZ20-J-T20HS
	4 prnp (source)	8 prnp (source)
Output type	P-MOSFET (open drain)	
Isolation	None	
Output current	0.5A maximum	
Maximum frequency	50Hz (resistive load) 0.5Hz (inductive load) 3kHz (with resistance load< 4kΩ) only O0-O2 in JZ20-J-T20HS	
Short circuit protection	Yes	
Short circuit indication	Yes	
On voltage drop	0.5VDC maximum	
Power supply for outputs		
Operating voltage	20.4 to 28.8VDC	
Nominal voltage	24VDC	

Sink Digital Outputs (JZ20-J-T20HS only)

Number of outputs	2 npn (sink)
Output type	N-MOSFET (open drain)
Galvanic Isolation	None
Maximum output current (resistive load)	100mA per output
H50 freq. range with resistive load	1Hz-32kHz (at maximum load resistance of 1kΩ)
On voltage drop	1VDC maximum
Short-circuit protection	None
Voltage range	3.5V to 28.8VDC

Analog Inputs

	JZ20-T18/JZ20-J-T18/JZ20-J-T20HS only	
Number of inputs	4, according to wiring as described above in Note 3	
	AN0 and AN1	AN2 and AN3
Input range	0-20mA, 4-20mA	0-10VDC
Input impedance	154Ω	20KΩ
Maximum input rating	30mA	28.8V
Galvanic isolation	None	
Conversion method	Successive approximation	

Resolution	10 or 12-bit (0 to 4095) (Via Software)
Conversion time	All analog inputs are updated every 8 PLC scans, regardless of how many inputs are actually configured.
Precision	± 2%
Status indication	Yes – if an analog input deviates above the permissible range, its value will be 4096.
Input cable length	Up to 30 meters, shielded twisted pair

Display

Type	STN LCD
Illumination backlight	LED, yellow-green, software controlled (LCD backlight; enables the display to be viewed in the dark)
Display size	2 lines, 16 characters long
Character size	5x8 matrix, 2.95x5.55mm

Keyboard

Number of keys	16 keys, including 10 user-labeled keys
Key type	Metal dome, sealed membrane switch
Slides	Slides may be installed in the operating panel faceplate to custom-label the keys and logo picture. An extra logo slide is included. A complete set of blank slides is available by separate order.

Program

Ladder code memory	48K (virtual)
Execution time	1.5 µSec for bit operations (typical)
Memory bits (coils)	256
Memory integers (registers), 16 bit	256
Timers	64
HMI displays	60 user-designed displays available
HMI variables	64 HMI variables are available to conditionally display text and data. List variables add up to 1.5K's worth of HMI capacity.

Communication

	Via a built-in USB port or - Add-On module. See Note 6-9
GSM-support	SMS messages to/from 6 phone GSM numbers, up to 1K of user-designed messages. Supports Remote Access.
MODBUS	Supports MODBUS protocol, Master-Slave
Baud rate	According to add-on port module
USB	
Port type	Mini-B
Galvanic isolation	No
Specification	USB 2.0 compliant; full speed
Baud rate range	300 to 115200 bps
Cable	USB 2.0 compliant; up to 3m

Notes:

6. The JZ20 built-in USB port may be used for programming. Add-on Modules are available by separate order for communication and cloning. Note that the USB port and an Add-on module cannot be physically connected at the same time.
7. Add-on module JZ-PRG, with 6-wires communication cable (supplied in PRG kit – see the JZ-PRG Installation Guide) can be used:
 - for programming
 - to connect a modem
8. Add-on module JZ-RS4 (RS232/485), with a standard 4-wire communication cable can be used:
 - for programming
 - to communicate with other devices (including modems/GSM)
 - for RS485 networking.
9. Add-on module MJ20-ET1 enables communication over 100 Mbit/s TCP/IP network:
 - Programming/data exchange with Unitronics software;
 - Data exchange via MODBUS TCP as Master or Slave.

Miscellaneous

Clock (RTC)	Real-time clock functions (date and time).
-------------	--

Environmental

Operating temperature	0° to 50°C (32° to 122°F)
Storage temperature	-20° to 60° C (-4° to 140°F)
Relative humidity (RH)	10% to 95% (non-condensing)
Mounting method	Panel mounted (IP65/NEMA4X) DIN-rail mounted (IP20/NEMA1)

Dimensions

Size	147.5X117X46.6mm (5.807" X 4.606" X 1.835"). See Note 10
Weight	300 g (10.6 oz)

Notes:

10. For exact dimensions, refer to Page 2.

Mounting

Panel mounting	Insert into cut-out: 117 x 89mm (WxH) 4.606"x 3.504"
DIN-rail mounting	Snap unit onto the DIN rail

The information in this document reflects products at the date of printing. Unitronics reserves the right, subject to all applicable laws, at any time, at its sole discretion, and without notice, to discontinue or change the features, designs, materials and other specifications of its products, and to either permanently or temporarily withdraw any of the foregoing from the market.

All information in this document is provided "as is" without warranty of any kind, either expressed or implied, including but not limited to any implied warranties of merchantability, fitness for a particular purpose, or non-infringement. Unitronics assumes no responsibility for errors or omissions in the information presented in this document. In no event shall Unitronics be liable for any special, incidental, indirect or consequential damages of any kind, or any damages whatsoever arising out of or in connection with the use or performance of this information.

The tradenames, trademarks, logos and service marks presented in this document, including their design, are the property of Unitronics (1989) (R'G) Ltd. or other third parties and you are not permitted to use them without the prior written consent of Unitronics or such third party as may own them