

EX-D16A3-RO8

User Guide

XL I/O Expansion Module (Built-in Adapter)

The Unitronics® EX-D16A3-RO8 is an XL I/O expansion module for use in conjunction with specific Unitronics controllers. XL modules comprise enhanced I/O configurations and detachable I/O connectors. In addition, this module comprises a built-in adapter for communicating with the PLC and providing power to the other expansion modules in the system.

This module provides:

- 16 digital inputs, including 2 HSC
- 3 analog inputs
- 8 relay outputs

For additional information and technical specifications, visit the Technical Library at www.unitronicsplc.com

Component Identification

1	Power supply connector
2	Status indicators
3	Output connectors
4	Output power supply connection points
5	PLC expansion port (for communication with the PLC)
6	Input/output status indicators
7	Module-to-module connector port
8	Input connectors

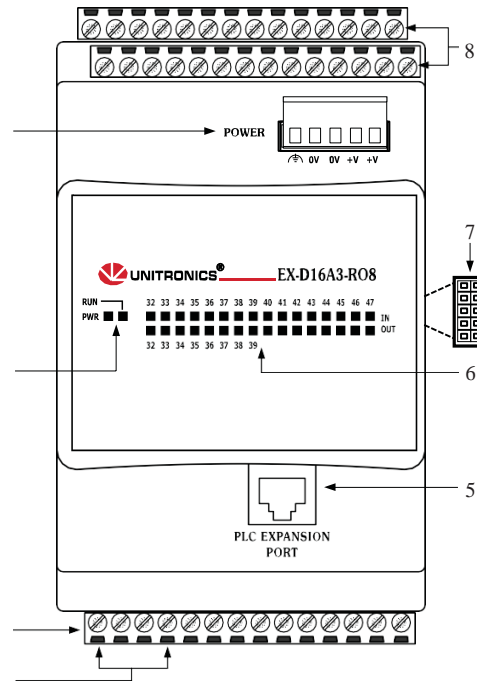

- Failure to comply with appropriate safety guidelines can cause severe personal injury or damage to property.



- Only qualified personnel should service and operate this device.
- When power is turned on, do not connect or disconnect the device to avoid damaging the system.

Alert Symbols and General Restrictions

When any of the following symbols appear, read the associated information carefully.

Symbol	Meaning	Description
	Danger	The identified danger causes physical and property damage.
	Warning	The identified danger could cause physical and property damage.
Caution	Caution	Use caution.

- Before using this product, the user must read and understand this document.
- All examples and diagrams are intended to aid understanding, and do not guarantee operation. Unitronics accepts no responsibility for actual use of this product based on these examples.
- Please dispose of this product according to local and national standards and regulations.
- Only qualified service personnel should open this device or carry out repairs.



- Failure to comply with appropriate safety guidelines can cause severe injury or property damage.



- Do not attempt to use this device with parameters that exceed permissible levels.
- To avoid damaging the system, do not connect/disconnect the device when power is on.

Environmental Considerations



- Do not install in areas with: excessive or conductive dust, corrosive or flammable gas, moisture or rain, excessive heat, regular impact shocks or excessive vibration, in accordance with the standards given in the product's technical specification sheet.
- Do not place in water or let water leak onto the unit.
- Do not allow debris to fall inside the unit during installation.



- Ventilation: 10mm space required between controller's top/bottom edges & enclosure walls.
- Install at maximum distance from high-voltage cables and power equipment.

UL Compliance

The following section is relevant to Unitronics' products that are listed with the UL.

The following models: IO-AI4-AO2, IO-AO6X, IO-ATC8, IO-DI16, IO-DI16-L, IO-DI8-RO4, IO-DI8-RO4-L, IO-DI8-TO8, IO-DI8-TO8-L, IO-RO16, IO-RO16-L, IO-RO8, IO-RO8L, IO-TO16, EX-A2X are UL listed for Hazardous Locations.

The following models: EX-D16A3-RO8, EX-D16A3-RO8L, EX-D16A3-TO16, EX-D16A3-TO16L, IO-AI1X-AO3X, IO-AI4-AO2, IO-AI4-AO2-B, IO-AI8, IO-AI8Y, IO-AO6X, IO-ATC8, IO-D16A3-RO16, IO-D16A3-RO16L, IO-D16A3-TO16, IO-D16A3-TO16L, IO-DI16, IO-DI16-L, IO-DI8-RO4, IO-DI8-RO4-L, IO-DI8-RO8, IO-DI8-RO8-L, IO-DI8-TO8, IO-DI8-TO8-L, IO-DI8ACH, IO-LC1, IO-LC3, IO-PT4, IO-PT400, IO-PT4K, IO-RO16, IO-RO16-L, IO-RO8, IO-RO8L, IO-TO16, EX-A2X, EX-RC1 are UL listed for Ordinary Location.

UL Ratings, Programmable Controllers for Use in Hazardous Locations,

Class I, Division 2, Groups A, B, C and D

These Release Notes relate to all Unitronics products that bear the UL symbols used to mark products that have been approved for use in hazardous locations, Class I, Division 2, Groups A, B, C and D.

Caution



- This equipment is suitable for use in Class I, Division 2, Groups A, B, C and D, or Non-hazardous locations only.
 - Input and output wiring must be in accordance with Class I, Division 2 wiring methods and in accordance with the authority having jurisdiction.
 - WARNING—Explosion Hazard—substitution of components may impair suitability for Class I, Division 2.
 - WARNING – EXPLOSION HAZARD – Do not connect or disconnect equipment unless power has been switched off or the area is known to be non-hazardous.
 - WARNING – Exposure to some chemicals may degrade the sealing properties of material used in Relays.
 - This equipment must be installed using wiring methods as required for Class I, Division 2 as per the NEC and/or CEC.
-

Relay Output Resistance Ratings

The products listed below contain relay outputs:

Input/Output expansion modules, Models: IO-DI8-RO4, IO-DI8-RO4-L, IO-RO8, IO-RO8L

- When these specific products are used in hazardous locations, they are rated at 3A res, when these specific products are used in non-hazardous environmental conditions, they are rated at 5A res, as given in the product's specifications.

Certification UL des automates programmables, pour une utilisation en environnement à risques, Class I, Division 2, Groups A, B, C et D.

Cette note fait référence à tous les produits Unitronics portant le symbole UL - produits qui ont été certifiés pour une utilisation dans des endroits dangereux, Classe I, Division 2, Groupes A, B, C et D.

Attention



- Cet équipement est adapté pour une utilisation en Classe I, Division 2, Groupes A, B, C et D, ou dans Non-dangereux endroits seulement.
 - Le câblage des entrées/sorties doit être en accord avec les méthodes de câblage selon la Classe I, Division 2 et en accord avec l'autorité compétente.
 - AVERTISSEMENT: Risque d'Explosion – Le remplacement de certains composants rend caduque la certification du produit selon la Classe I, Division 2.
 - AVERTISSEMENT - DANGER D'EXPLOSION - Ne connecter pas ou ne débranche pas l'équipement sans avoir préalablement coupé l'alimentation électrique ou la zone est reconnue pour être non dangereuse.
 - AVERTISSEMENT - L'exposition à certains produits chimiques peut dégrader les propriétés des matériaux utilisés pour l'étanchéité dans les relais.
 - Cet équipement doit être installé utilisant des méthodes de câblage suivant la norme Class I, Division 2 NEC et /ou CEC.
-

Certification de la résistance des sorties relais

Les produits énumérés ci-dessous contiennent des sorties relais:

- Modules d'Extensions d'E/S, modèles: IO-DI8-RO4, IO-DI8-RO4-L, IO-RO8, IO-RO8L.
- Lorsque ces produits spécifiques sont utilisés dans des endroits dangereux, ils supportent un courant de 3A charge résistive, lorsque ces produits spécifiques sont utilisés dans un environnement non dangereux, ils sont évalués à 5A res, comme indiqué dans les spécifications du produit Plages de températures.

Mounting the Module

To mount the module on a 35mm DIN-rail, snap it squarely onto the DIN-rail, as shown below.

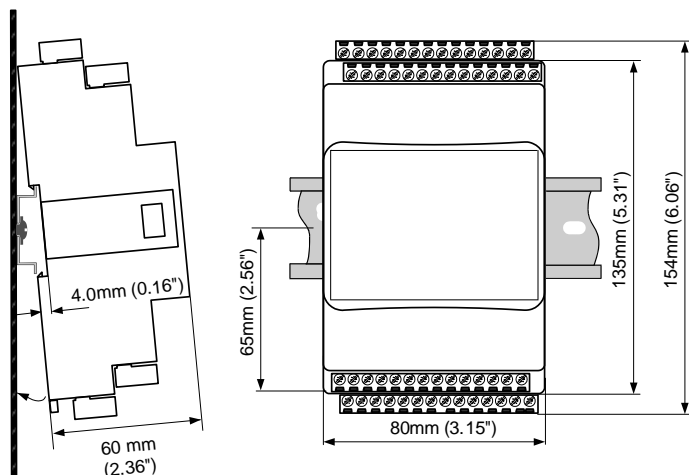

- Install the module in an upright position.
- To ensure good ventilation, leave at least 50mm between the device and all other objects above or below it.
- Install at a maximum distance from high-voltage cables and power equipment.

Connecting Modules

To connect a module to the adapter or expansion module:

1. Push the module-to-module connector (1) into the port (2) located on the right side of the module or adapter.
2. Push the protective cap (3) into the connector port of the last module. The cap is supplied with the adapter.

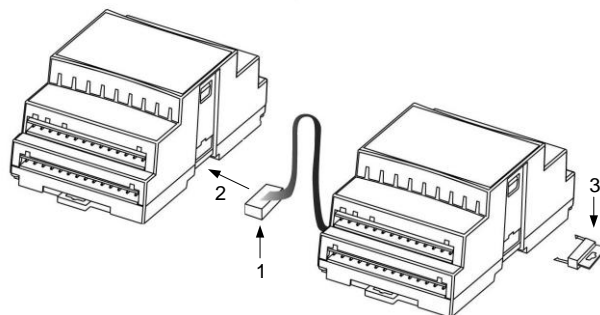

Connecting the Module to the PLC

Use the communication cable to connect the module's PLC expansion port to the PLC.

Take care to connect the correct cable. The connectors of this cable are housed in yellow insulation. Note that one end is marked To PLC and the other To Adapter; insert accordingly.

The module is supplied with a 1-meter cable, part number EXL-CAB100. Other cable lengths are also available.

Use only an original Unitronics cable and do not make any changes to it.

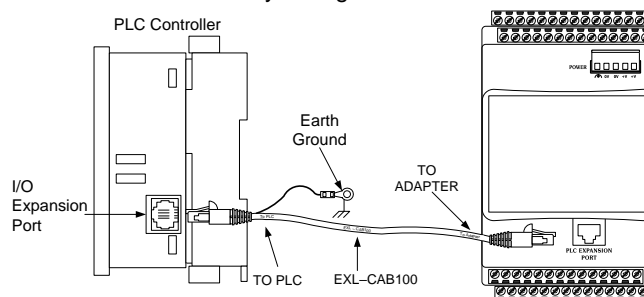

Wiring



- Do not touch live wires.

- This equipment is designed to operate only in SELV/PELV/Class 2/Limited Power environments.
- All power supplies in the system must include double insulation. Power supply outputs must be rated as SELV/PELV/Class 2/Limited Power.



- Do not connect either the 'Neutral' or 'Line' signal of the 110/220VAC to device's 0V pin.
- All wiring activities should be performed while power is OFF.
- Use over-current protection, such as a fuse or circuit breaker, to avoid excessive currents into the power supply connection point.
- Unused points should not be connected (unless otherwise specified). Ignoring this directive may damage the device.
- Double-check all wiring before turning on the power supply.

Caution

- To avoid damaging the wire, do not exceed a maximum torque of:
 - Controllers offering a terminal block with pitch of 5mm: 0.5 N·m (5 kgf·cm).
 - Controllers offering a terminal block with pitch of 3.81mm f 0.2 N·m (2 kgf·cm).
- Do not use tin, solder, or any substance on stripped wire that might cause the wire strand to break.
- Install at maximum distance from high-voltage cables and power equipment.

Wiring Procedure

Use crimp terminals for wiring;

- Controllers offering a terminal block with pitch of 5mm: 26-12 AWG wire (0.13 mm² –3.31 mm²).
 - Controllers offering a terminal block with pitch of 3.81mm: 26-16 AWG wire (0.13 mm² – 1.31 mm²).
1. Strip the wire to a length of 7±0.5mm (0.270–0.300").
 2. Unscrew the terminal to its widest position before inserting a wire.
 3. Insert the wire completely into the terminal to ensure a proper connection.
 4. Tighten enough to keep the wire from pulling free.

Wiring Guidelines

- Use separate wiring ducts for each of the following groups:
 - Group 1: Low voltage I/O and supply lines, communication lines.
 - Group 2: High voltage Lines, Low voltage noisy lines like motor driver outputs.Separate these groups by at least 10cm (4"). If this is not possible, cross the ducts at a 90° angle.
- For proper system operation, all 0V points in the system should be connected to the system 0V supply rail.
- Product-specific documentation must be fully read and understood before performing any wiring.

Allow for voltage drop and noise interference with input lines used over an extended distance.
Use wire that is properly sized for the load.

Earthing the product

To maximize system performance, avoid electromagnetic interference as follows:

- Use a metal cabinet.
- Connect the 0V and functional ground points (if exist) directly to the earth ground of the system.
- Use the shortest, less than 1m (3.3 ft.) and thickest, 2.08mm² (14AWG) min, wires possible.

Daisy Chaining

To facilitate wiring, you can wire the following pins in series (daisy chain). Use both pins provided for this purpose.

Input connector pin: n/p. Output connector pins: +V, 0V. Power connector pins: +V, 0V.

Ensure that the total current drain on any single line does not exceed 10A. If a specific pin requires more than 10A, connect it with a separate wire. The following diagram demonstrates the wiring options:

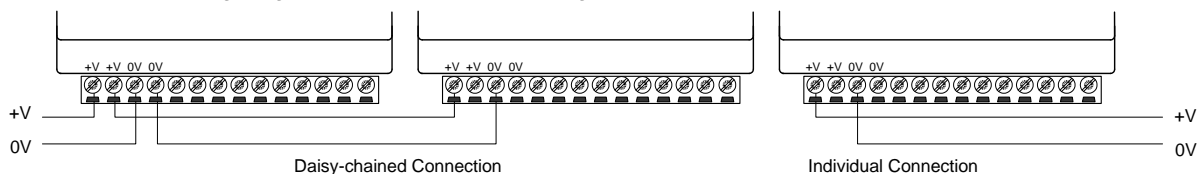

Wiring the Power Supply

- Always connect the functional earth pin to the earth ground. Use a dedicated wire for this purpose; it must not exceed 1 meter.
- A non-isolated power supply can be used provided that the 0V signal is connected to the earth ground.
- Do not connect the neutral or line signal of the 110/220VAC to the device's 0V pin.
- In the event of voltage fluctuations or non-conformity to voltage power supply specifications, connect the device to a regulated power supply.

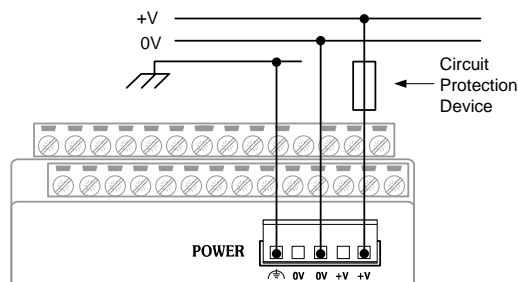

Wiring Inputs

The following diagram shows the input connectors with pin numbers and corresponding input numbers

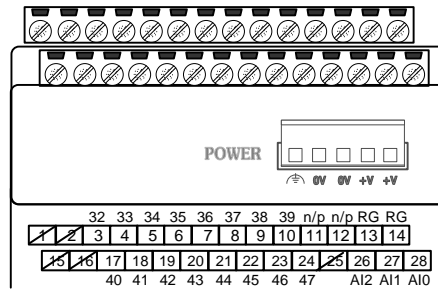

Wiring Digital Inputs

- Inputs may be wired as either pnp (positive logic) or npn (negative logic).
- Input 36 can function as a high-speed counter, frequency measurer, or general purpose digital input (set in software).
- Input 37 can function either as a counter reset input or general purpose digital input (set in software).
- For correct operation of the digital inputs, connect the n/p pin according to the following figures.
- For information on connecting RG pins, refer to
- Connecting RG Pins.

pnp (positive logic) inputs 32-39

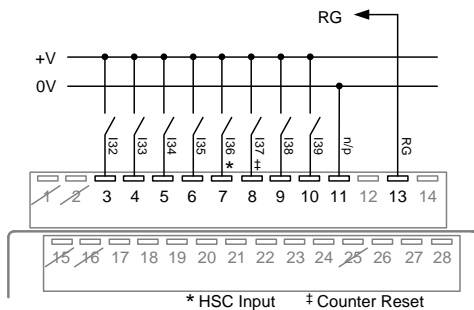

pnp (positive logic) inputs 40-47

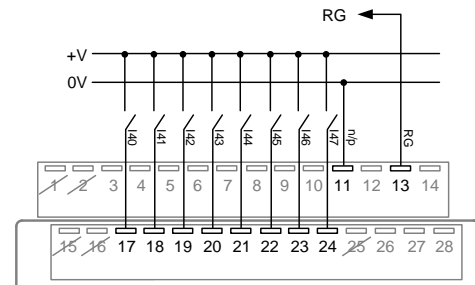

npn (negative logic) inputs 32-39

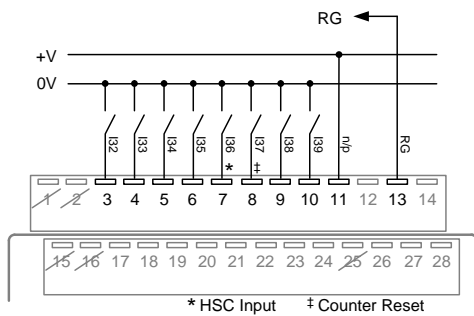

npn (negative logic) inputs 40-47

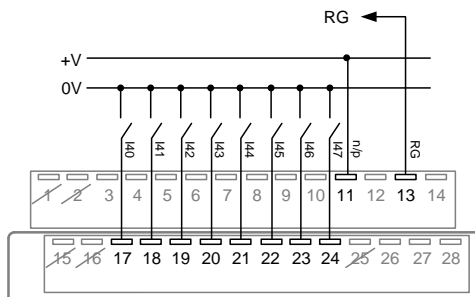

Wiring Analog Inputs

The following diagram shows the 2-wire and 4-wire current connection.

- Use shielded twisted pair cable.
- Connect shields to the earth ground at the signal's source.

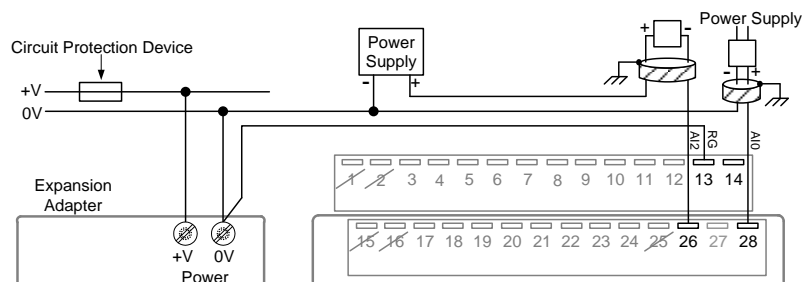

Connecting RG Pins

For correct operation of digital and analog inputs and for EMI immunity, connect the RG pin of all the expansion modules containing RG signals to the adapter 0V signal.

- The overall length of the wire connecting the RG pins to the adapter 0V signal must be less than 3 meters.
- Connect the RG pins in series (daisy chain). To facilitate this, use both the RG pins.

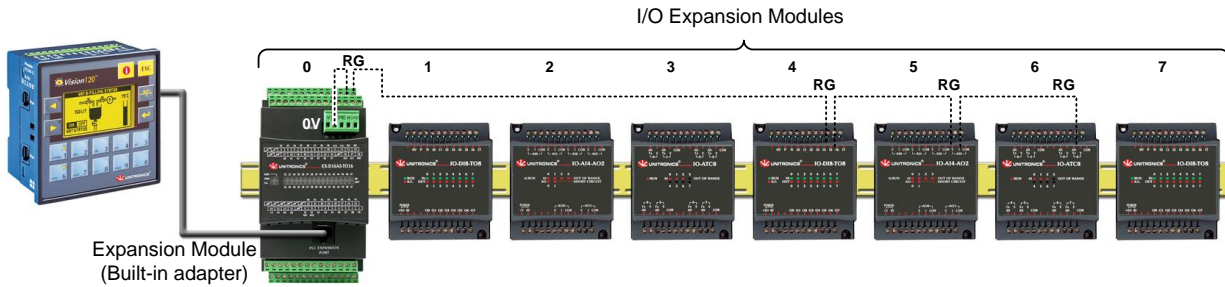

Wiring Outputs

The following diagram shows the output connectors with pin numbers and corresponding output numbers.

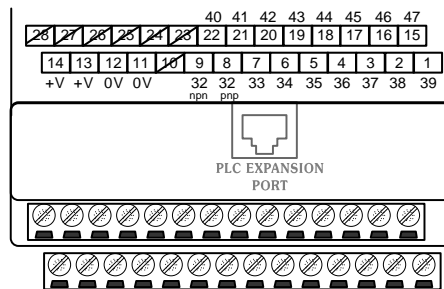

Wiring the Output Power Supply

- A non-isolated power supply can be used provided that the 0V signal is connected to the earth ground.
- Do not connect the neutral or line signal of the 110/220VAC to the device's 0V pin.
- In the event of voltage fluctuations or non-conformity to voltage power supply specifications, connect the device to a regulated power supply.
- The adapter 0V and the I/O 0V must connect to the same line, Ignoring this may damage the device.

Wiring Relay Outputs

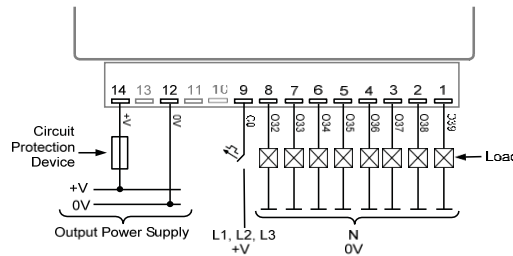

Increasing Contact Life span

To increase the life span of the relay contacts and protect against potential damage by reverse EMF, connect one of the following:

- A clamping diode in parallel with each inductive DC load.
- An RC snubber circuit in parallel with each inductive AC load.

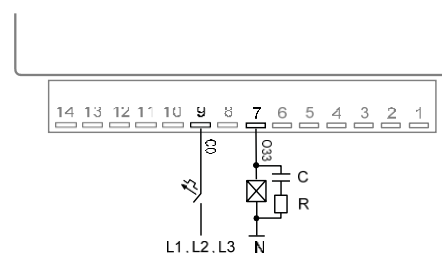
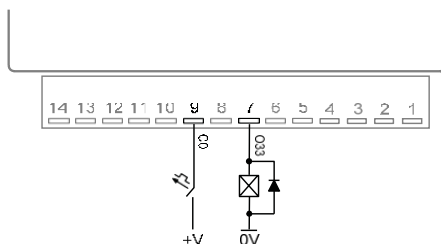

Technical Specifications

General

I/O module capacity	Up to 7 I/O expansion modules can be connected to this module. This number may vary according to the modules used.
Status indicators	
RUN: Green LED	■ Lights when a communication link is established between the module and the PLC
	■ Blinks when the communication link fails
PWR: Green LED	■ Lights when power is supplied

Power Supply

Input voltage	24VDC
Permissible range	20.4 to 28.8VDC, ripple < 10%
Maximum current consumption	90mA @ 24VDC – EX-D16A3-RO8 alone 220mA @ 24VDC – maximum load on the 5VDC supply when the EX-D16A3-RO8 powers seven additional I/O expansion modules
Current for additional modules	500mA maximum from 5VDC, see note 1

Notes:

1. For example, 2 IO-DI8-TO8 modules consume a maximum of 140mA of the adapter's 5VDC supply.
-

Digital Inputs

Number of inputs	16 (in a single group)
Input mode	pnp (positive logic) or npn (negative logic) – configurable by hard-wiring
Galvanic isolation	None
Status indicators	
IN: Green LEDs	■ One green LED for each input: Lights when the input is active, see note 2
Nominal input voltage	24VDC
Input voltage	
pnp (positive logic)	0–5VDC for logic state 0 17–28.8VDC for logic state 1
npn (negative logic)	17–28.8VDC for logic state 0 0–5VDC for logic state 1
Input current	3.7mA @ 24VDC
Input impedance	6.5k Ω
Response time	10ms typical
High-speed inputs	The specifications in this section apply when inputs are configured as high-speed counters or frequency measurers. If they are configured as general purpose digital inputs, the specification is as above. See notes 3, 4, and 5.
Resolution	16-bit or 32-bit, depending on the PLC
Frequency	30kHz maximum (at 24VDC \pm 10%)
Minimum pulse width	14 μ s

Notes:

2. If the input is active but there is no communication with the PLC (RUN blinks), the status LED does not light.
3. Inputs 36 and 38 can function either as high-speed counters, frequency measurers, or general purpose digital inputs.
4. Inputs 37 and 39 can function either as counter reset inputs or general purpose digital inputs. In both cases, the specifications of these inputs are those of a general purpose digital input.
5. If input 36 or 38 is set as a high-speed counter and no reset input is configured, input 37 or 39 functions as a general purpose digital input.

Analog Inputs

Number of inputs	3
Input type	0–20mA or 4–20mA
Input impedance	191Ω
Maximum input rating	28mA, 5.3VDC
Galvanic isolation	None
Cable type	Shielded twisted-pair
Conversion method	Successive approximation
Resolution (0-20mA)	10-bit (1024 units)
Resolution (4-20mA)	204 to 1023 (820 units)
Conversion time	Each configured input is sampled once per 1.67ms. For example, if 3 inputs are configured, it takes $3 \times 1.67 = 5\text{ms}$ to sample all the analog inputs. See note 6.
Accuracy	±0.9% of full scale
Status indication	In software: If a specific input value is 1024, a single analog input deviates above the permissible range. If all the input values are 1024, either all the inputs deviate above the permissible range or the RG signal is not connected.

Notes:

6. The conversion time does not include communication time with the PLC and PLC scan time.
-

Digital Outputs

Number of outputs	8 relays
Output type	SPST-NO (Form A)
Isolation	By relay
Status Indicators	
OUT: Red LEDs	■ One red LED for each output: Lights when the corresponding output is active
Type of relay	Tyco PCN-124D3MHz or compatible
Maximum output current	3A per output (resistive load) 8A total (resistive load), see note 7
Rated voltage	250VAC / 30VDC
Minimum load	1mA, 5VDC
Life expectancy	100k operations at maximum load
Response time	10ms (typical)
Contact protection	External precautions required (see <i>Increasing Contact Life Span</i> in the Installation Guide)
Output power supply	
Nominal operating voltage	24VDC
Operating voltage	20.4 to 28.8VDC
Maximum current consumption	40mA
@ 24VDC	

Notes:

7. Outputs 0–7 share the common signal C0.
-

Dimensions

Size (W x H x D)	80 x 135 x 60mm (3.15 x 5.31 x 2.36").
Weight (approximate)	360g (12.7oz)

Environmental

Operating temperature	0°C to 50°C (32°F to 122°F)
Storage temperature	–20°C to 60°C (–4°F to 140°F)
Relative Humidity (RH)	10% to 95% (non-condensing)
Mounting	Snap-mounted on 35mm DIN-rail (IP20/NEMA1)

The information in this document reflects products at the date of printing. Unitronics reserves the right, subject to all applicable laws, at any time, at its sole discretion, and without notice, to discontinue or change the features, designs, materials and other specifications of its products, and to either permanently or temporarily withdraw any of the forgoing from the market. All information in this document is provided "as is" without warranty of any kind, either expressed or implied, including but not limited to any implied warranties of merchantability, fitness for a particular purpose, or non-infringement. Unitronics assumes no responsibility for errors or omissions in the information presented in this document. In no event shall Unitronics be liable for any special, incidental, indirect or consequential damages of any kind, or any damages whatsoever arising out of or in connection with the use or performance of this information. The tradenames, trademarks, logos and service marks presented in this document, including their design, are the property of Unitronics (1989) (R^G) Ltd. or other third parties and you are not permitted to use them without the prior written consent of Unitronics or such third party as may own them.

UG_EX-D16A3-R08.pdf 12/22