



**EN** Operating instructions. . . . .pages 1 to 6  
Original

**Content**

**1 About this document**

1.1 Function . . . . . 1

1.2 Target group: authorised qualified personnel. . . . . 1

1.3 Explanation of the symbols used . . . . . 1

1.4 Appropriate use . . . . . 1

1.5 General safety instructions . . . . . 1

1.6 Warning against improper use . . . . . 1

1.7 Exclusion of liability . . . . . 2

**2 Product description**

2.1 Ordering code . . . . . 2

2.2 Special versions. . . . . 2

2.3 Purpose . . . . . 2

2.4 Technical data . . . . . 2

2.5 Safety classification . . . . . 2

**3 Mounting**

3.1 General mounting instructions . . . . . 3

3.2 Dimensions . . . . . 3

**4 Electrical connection**

4.1 General information for electrical connection. . . . . 3

4.2 Contact variants. . . . . 3

**5 Set-up and maintenance**

5.1 Functional testing. . . . . 4

5.2 Maintenance . . . . . 4

**6 Disassembly and disposal**

6.1 Disassembly. . . . . 4

6.2 Disposal. . . . . 4

**7 EU Declaration of conformity**

**1. About this document**

**1.1 Function**

This operating instructions manual provides all the information you need for the mounting, set-up and commissioning to ensure the safe operation and disassembly of the safety switchgear. The operating instructions must be available in a legible condition and a complete version in the vicinity of the device.

**1.2 Target group: authorised qualified personnel**

All operations described in this operating instructions manual must be carried out by trained specialist personnel, authorised by the plant operator only.

Please make sure that you have read and understood these operating instructions and that you know all applicable legislations regarding occupational safety and accident prevention prior to installation and putting the component into operation.

The machine builder must carefully select the harmonised standards to be complied with as well as other technical specifications for the selection, mounting and integration of the components.

**1.3 Explanation of the symbols used**



**Information, hint, note:**

This symbol indicates useful additional information.



**Caution:** Failure to comply with this warning notice could lead to failures or malfunctions.

**Warning:** Failure to comply with this warning notice could lead to physical injury and/or damage to the machine.

**1.4 Appropriate use**

The Schmersal range of products is not intended for private consumers.

The products described in these operating instructions are developed to execute safety-related functions as part of an entire plant or machine. It is the responsibility of the manufacturer of a machine or plant to ensure the correct functionality of the entire machine or plant.

The safety switchgear must be exclusively used in accordance with the versions listed below or for the applications authorised by the manufacturer. Detailed information regarding the range of applications can be found in the chapter "Product description".

**1.5 General safety instructions**

The user must observe the safety instructions in this operating instructions manual, the country specific installation standards as well as all prevailing safety regulations and accident prevention rules.



Further technical information can be found in the Schmersal catalogues or in the online catalogue on the Internet: [products.schmersal.com](http://products.schmersal.com).

The information contained in this operating instructions manual is provided without liability and is subject to technical modifications.

There are no residual risks, provided that the safety instructions as well as the instructions regarding mounting, commissioning, operation and maintenance are observed.

**1.6 Warning against improper use**



In case of improper use or manipulation of the safety switchgear, personal hazards or damages to machinery or plant components cannot be excluded. The relevant requirements of the standard EN ISO 14119 must be observed.

### 1.7 Exclusion of liability

We shall accept no liability for damages and malfunctions resulting from defective mounting or failure to comply with this operating instructions manual. The manufacturer shall accept no liability for damages resulting from the use of unauthorised spare parts or accessories.

For safety reasons, invasive work on the device as well as arbitrary repairs, conversions and modifications to the device are strictly forbidden, the manufacturer shall accept no liability for damages resulting from such invasive work, arbitrary repairs, conversions and/or modifications to the device.

## 2. Product description

### 2.1 Ordering code

This operating instructions manual applies to the following types:

#### EX-AZM 415-①ZPK②-24VAC/DC-③-3D

No.	Option	Description
①	11 / 11	2 NC contacts / 2 NO contacts
	02 / 11	3 NC contacts / 1 NO contact
	02 / 20	2 NC contacts / 2 NO contacts
	02 / 02	4 NC contacts
②	A	Power to unlock
		Power to lock
③	1637	Gold-plated contacts



Only if the information described in this operating instructions manual are realised correctly, the safety function and therefore the compliance with the Machinery Directive and the Explosion Protection Directive is maintained.

### 2.2 Special versions

For special versions, which are not listed in the order code below 2.1, these specifications apply accordingly, provided that they correspond to the standard version.

### 2.3 Purpose

The solenoid interlock has been designed to prevent in conjunction with the control part of a machine, movable safety guards from being opened before hazardous conditions have been eliminated. The components can be used in potentially explosive atmospheres of Zone 22 equipment category 3D. The installation and maintenance requirements to the standard series 60079 must be met.

### Conditions for safe operation

Due to the specific impact energy, the components must be fitted with a protection against mechanical stresses. The specific ambient temperature range must be observed.



Interlocks with power to lock principle may only be used in special cases after a thorough evaluation of the accident risk, since the guarding device can immediately be opened on failure of the electrical power supply or when the main switch is opened.



The safety switchgears are classified according to EN ISO 14119 as type 2 interlocking devices.



The user must evaluate and design the safety chain in accordance with the relevant standards and the required safety level.



The entire concept of the control system, in which the safety component is integrated, must be validated to the relevant standards.

### 2.4 Technical data

Designation in accordance with the ATEX Directive:	⊕ II 3GD
Designation in accordance with standards:	Ex tc IIIC T90°C Dc X
Applied standards:	EN 60947-5-1, EN ISO 14119, EN IEC 60079-0, EN 60079-31
Enclosure:	light-alloy die-cast, enamel finish
Max. impact energy:	4 J
Actuator:	zinc-plated brass / aluminium
Holding force $F_{Zh}$ :	3,500 N
Holding force $F_{max}$ :	4,550 N
Latching force:	80 ... 400 N (adjustable)
Coding level according to EN ISO 14119:	low
Degree of protection:	IP67 to EN 60529, IP6X to EN 60079-31
Degree of pollution:	3
Contact material:	Silver
Contact type:	Change-over contact with double break type Zb, with galvanically separated contact bridges
Switching system:	⊖ EN 60947-5-1, slow action, NC contact with positive break
Connection:	screw terminals
Cable section:	max. 2.5 mm <sup>2</sup> (incl. conductor ferrules)
Rated impulse withstand voltage $U_{imp}$ :	4 kV
Rated insulation voltage $U_i$ :	250 V
Thermal test current $I_{the}$ :	6 A
Utilisation category:	AC-15
Rated operating current $I_o$ :	4 A
Rated operating voltage $U_o$ :	230 VAC
Max. fuse rating:	6 A gG D-fuse
Required short-circuit current:	1,000 A
Positive break travel (unlocked):	5 mm
Positive break force (unlocked):	min. 15 N (depending on the setting of the ball latch)
Rated control voltage $U_c$ :	24 VAC / DC
Magnet switch-on time:	100 %
Power consumption:	max. 10 W
Ambient temperature:	-10 °C ... +50 °C
Actuating speed:	max. 1 m/s
Max. actuating frequency:	2,000 / h
Mechanical life:	max. 1,000,000 operations
Tightening torque:	Cover screws: min. 1 Nm; Bottom cover screws: min. 0.7 Nm; Cable gland: min. 8 Nm; Blocking screws: min. 8 Nm
Cable glands:	⊕ II 2GD
Terminals:	Ø 7 ... 12 mm

### 2.5 Safety classification

Standards:	EN ISO 13849-1
Envisaged structure:	
- Basically:	applicable up to Cat. 1 / PL c
- With 2-channel usage and fault exclusion mechanism*:	applicable up to Cat. 3 / PL d with suitable logic unit
$B_{10D}$ NC contact:	2,000,000
$B_{10D}$ NO contact at 10% ohmic contact load:	1,000,000
Mission time:	20 years
* If a fault exclusion to the 1-channel mechanics is authorised.	

$$MTTF_D = \frac{B_{10D}}{0,1 \times n_{op}} \quad n_{op} = \frac{d_{op} \times h_{op} \times 3600 \text{ s/h}}{t_{cycle}}$$

(Determined values can vary depending on the application-specific parameters  $h_{op}$ ,  $d_{op}$  and  $t_{cycle}$  as well as the load.)

If multiple safety components are wired in series, the Performance Level to EN ISO 13849-1 will be reduced due to the restricted error detection under certain circumstances.

### 3. Mounting

#### 3.1 General mounting instructions



Fitting is only authorised in a de-energised condition. The enclosure must be mechanically protected.

Four mounting holes are provided for fixing the enclosure. The use of a protective ground wire is imperative. The enclosure must not be used as an end stop. Any mounting position. The mounting position must be chosen so as to avoid the penetration of dirt in the used holes.



Please observe the recommendations regarding maximum impact energy, actuating speed and tightening torque in the technical data. The distance between the actuator flange and the switch enclosure must be  $< 3 \text{ mm}$  when the actuator is inserted.

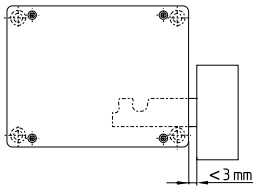

**Mounting of the actuators:** See mounting instructions actuators. The actuators AZ/AZM 415-B1, -B2 and -B3 are authorised for use in conjunction with the EX-AZM 415.



Please observe the remarks of the standards EN ISO 12100, EN ISO 14119 and EN ISO 14120.



The actuator must be permanently fitted to the safety guards and protected against displacement by suitable measures (tamperproof screws, gluing, drilling, pinning).

#### 3.2 Dimensions

All measurements in mm.

#### Solenoid interlock

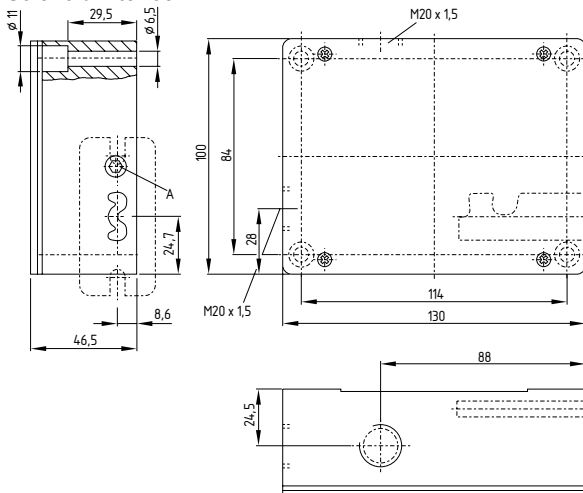

#### Key

A setting screw: ball latch 80 ... 400 N

### 4. Electrical connection

#### 4.1 General information for electrical connection



The electrical connection may only be carried out by authorised personnel in a de-energised condition.

The contact labelling can be found in the wiring compartment of the switch.



If the risk analysis indicates the use of a monitored interlock they are to be connected in the safety circuit with the contacts indicated with the symbol  $\overline{I}$ .

**Settle length x of the conductor:** 6 mm



Only use Ex cable glands and Ex blanking plugs with integrated or associated seals which are authorised for the corresponding field of application. The cable glands must be fitted in accordance with the applicable operating instructions manual. Cable glands are only authorised for permanent cables. The constructor must provide for the necessary strain relief. Unused cable entries must be sealed by means of Ex approved locking screws. Cable glands and locking screws are included in the delivery.

#### 4.2 Contact variants

Contacts shown in a de-energised condition and with the actuator inserted.

#### Power to unlock

##### EX-AZM 415-11/11ZPK...-3D

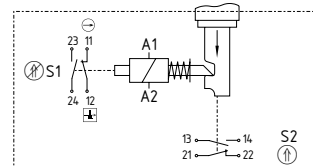

##### EX-AZM 415-11/02ZPK...-3D

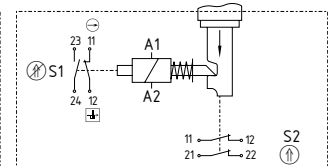

##### EX-AZM 415-11/20ZPK...-3D

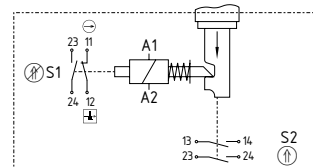

##### EX-AZM 415-02/11ZPK...-3D

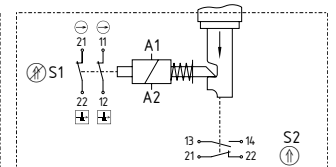

##### EX-AZM 415-02/02ZPK...-3D

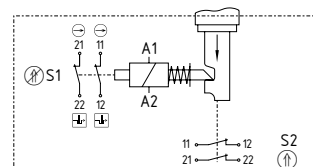

##### EX-AZM 415-02/20ZPK...-3D

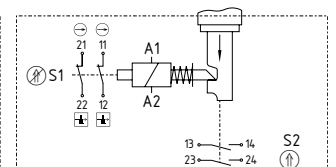

### Power to lock

EX-AZM 415-11/11ZPKA...-3D

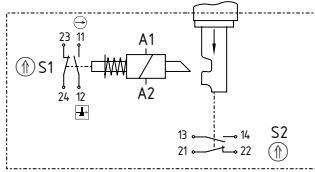

EX-AZM 415-11/02ZPKA...-3D

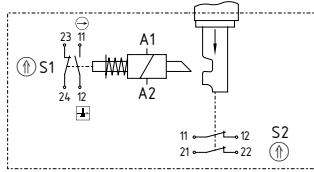

EX-AZM 415-11/20ZPKA...-3D

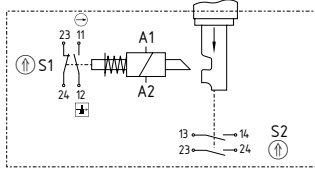

EX-AZM 415-02/11ZPKA...-3D

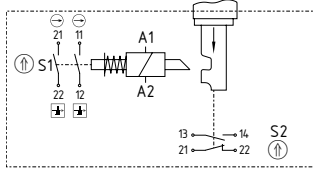

EX-AZM 415-02/02ZPKA...-3D

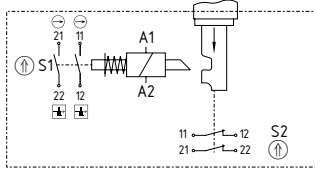

EX-AZM 415-02/20ZPKA...-3D

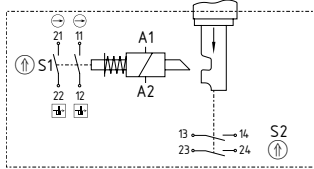

#### Legend:

- ⊖ Positive break
- ⊕ Monitoring the interlock according to EN ISO 14119
- ⊕ Actuated
- ⊖ Not actuated



Information for the selection of suitable safety-monitoring modules can be found in the Schmersal catalogues or in the online catalogue on our website: [products.schmersal.com](http://products.schmersal.com).

## 5. Set-up and maintenance

### 5.1 Functional testing

The safety function of the safety components must be tested. The following conditions must be previously checked and met:

- The installation is executed according to the instructions
- The connection is executed correctly
- The cable is correctly executed and connected
- The safety component is not damaged
- Remove particles of dust and soiling
- Check cable entry and connections

### 5.2 Maintenance

In case of correct installation in accordance with the instructions described above, the component requires little maintenance. For use in extreme conditions, we recommend routine maintenance including the following steps:

1. Check the correct fixing of the actuator and the safety switchgear
2. Remove particles of dust and soiling
3. Check cable entry and connections in a de-energised condition



Do not open the device when live.



Adequate measures must be taken to ensure protection against tampering either to prevent tampering of the safety guard, for instance by means of replacement actuators.

**For explosion protection reasons, the component must be exchanged after max. 1 million operations.**

**Damaged or defective components must be replaced.**

## 6. Disassembly and disposal

### 6.1 Disassembly

The safety switchgear must be disassembled in a de-energised condition only.

### 6.2 Disposal

The safety switchgear must be disposed of in an appropriate manner in accordance with the national prescriptions and legislations.

7. EU Declaration of conformity

EU Declaration of conformity



Original  
K.A. Schmersal GmbH & Co. KG  
Möddinghofe 30  
42279 Wuppertal  
Germany  
Internet: www.schmersal.com

We hereby certify that the hereafter described components both in their basic design and construction conform to the applicable European Directives.

**Name of the component:** EX-AZM 415

**Type:** see ordering code

**Marking:** II 3D Ex tc IIIC T90°C Dc X

**Description of the component:** Interlocking device with electromagnetic interlock for safety functions

**Relevant Directives:** Machinery Directive 2006/42/EC  
Explosion Protection Directive (ATEX) 2014/34/EU  
RoHS-Directive 2011/65/EU

**Applied standards:** EN 60947-5-1:2017  
EN ISO 14119:2013  
EN IEC 60079-0:2018  
EN 60079-31:2014

**Person authorised for the compilation of the technical documentation:** Oliver Wacker  
Möddinghofe 30  
42279 Wuppertal

**Place and date of issue:** Wuppertal, February 15, 2022

Authorised signature  
**Philip Schmersal**  
Managing Director

EX-AZM415-F-EN



The currently valid declaration of conformity can be downloaded from the internet at [products.schmersal.com](http://products.schmersal.com).



**K.A. Schmersal GmbH & Co. KG**  
Möddinghofe 30, 42279 Wuppertal  
Germany  
Phone: +49 202 6474-0  
Telefax: +49 202 6474-100  
E-Mail: [info@schmersal.com](mailto:info@schmersal.com)  
Internet: [www.schmersal.com](http://www.schmersal.com)