



EN Operating instructions.pages 1 to 8
Original

Content

1 About this document

1.1 Function 1

1.2 Target group: authorised qualified personnel. 1

1.3 Explanation of the symbols used 1

1.4 Appropriate use 1

1.5 General safety instructions 1

1.6 Warning about misuse 1

1.7 Exclusion of liability 2

2 Product description

2.1 Ordering code 2

2.2 Special versions. 2

2.3 Purpose 2

2.4 Technical data 3

2.5 Safety classification of the interlocking function. 3

2.6 Safety classification of the guard locking function 3

3 Mounting

3.1 General mounting instructions 4

3.2 Dimensions 4

4 Electrical connection

4.1 General information for electrical connection. 6

4.2 Contact variants 6

5 Set-up and maintenance

5.1 Functional testing. 7

5.2 Maintenance 7

6 Disassembly and disposal

6.1 Disassembly. 7

6.2 Disposal 7

7 EU Declaration of conformity

1. About this document

1.1 Function

This operating instructions manual provides all the information you need for the mounting, set-up and commissioning to ensure the safe operation and disassembly of the safety switchgear. The operating instructions must be available in a legible condition and a complete version in the vicinity of the device.

1.2 Target group: authorised qualified personnel

All operations described in this operating instructions manual must be carried out by trained specialist personnel, authorised by the plant operator only.

Please make sure that you have read and understood these operating instructions and that you know all applicable legislations regarding occupational safety and accident prevention prior to installation and putting the component into operation.

The machine builder must carefully select the harmonised standards to be complied with as well as other technical specifications for the selection, mounting and integration of the components.

1.3 Explanation of the symbols used



Information, hint, note:

This symbol is used for identifying useful additional information.



Caution: Failure to comply with this warning notice could lead to failures or malfunctions.

Warning: Failure to comply with this warning notice could lead to physical injury and/or damage to the machine.

1.4 Appropriate use

The products described in these operating instructions are developed to execute safety-related functions as part of an entire plant or machine. It is the responsibility of the manufacturer of a machine or plant to ensure the correct functionality of the entire machine or plant.

The safety switchgear must be exclusively used in accordance with the versions listed below or for the applications authorised by the manufacturer. Detailed information regarding the range of applications can be found in the chapter "Product description".

1.5 General safety instructions

The user must observe the safety instructions in this operating instructions manual, the country specific installation standards as well as all prevailing safety regulations and accident prevention rules.



Further technical information can be found in the Schmersal catalogues or in the online catalogue on the Internet: products.schmersal.com.

The information contained in this operating instructions manual is provided without liability and is subject to technical modifications.

There are no residual risks, provided that the safety instructions as well as the instructions regarding mounting, commissioning, operation and maintenance are observed.

1.6 Warning about misuse



In case of improper use or manipulation of the safety switchgear, personal hazards or damages to machinery or plant components cannot be excluded. The relevant requirements of the standard EN ISO 14119 must be observed.

1.7 Exclusion of liability

We shall accept no liability for damages and malfunctions resulting from defective mounting or failure to comply with this operating instructions manual. The manufacturer shall accept no liability for damages resulting from the use of unauthorised spare parts or accessories.

For safety reasons, invasive work on the device as well as arbitrary repairs, conversions and modifications to the device are strictly forbidden, the manufacturer shall accept no liability for damages resulting from such invasive work, arbitrary repairs, conversions and/or modifications to the device.

2. Product description

2.1 Ordering code

This operating instructions manual applies to the following types:

AZM 170^{①-②}Z^③I^④⑤-⑥-⑦ 24 VAC/DC

No.	Option	Description
①	SK ST	Screw terminals M12 x 1 connector
②		Magnet contacts:
	12 / 11	1 NO / 2 NC
	12 / 02	1 NO / 2 NC
	12 / 00	1 NO / 2 NC
	11 / 11	1 NO / 1 NC
	11 / 02	1 NO / 1 NC
	02 / 10	2 NC
	02 / 01	2 NC
③		Latching force 5 N
	R	Latching force 30 N
④		Power to unlock
	A	Power to lock
⑤	B1 B5 B6L B6R	Actuator B1 included Actuator B5 included Actuator B6L included Actuator B6R included
⑥	1637	Gold-plated contacts
⑦	2197	Manual release for Power to unlock

AZM 170^{①-②}Z^③I^④⑤-⑥-⑦ ⑧

No.	Option	Description
①	SK	Cut clamps Screw terminals
②	11 02	1 NO / 1 NC 2 NC
③		Latching force 5 N
	R	Latching force 30 N
④		Power to unlock
	A	Power to lock
⑤		Cable gland
	ST	M12 x 1 connector
	ST-2431	M12 connector, separated magnet monitoring
⑥	B1 B5 B6L B6R	Actuator B1 included Actuator B5 included Actuator B6L included Actuator B6R included
⑦		Manual release
	2197	Manual release from side (default in the connector and power-to-unlock version)
	1637	Gold-plated contacts
⑧	24 VAC/DC 110 VAC 230 VAC	U _s 24 VAC/DC U _s 110 VAC U _s 230 VAC



Only if the information described in this operating instructions manual are realised correctly, the safety function and therefore the compliance with the Machinery Directive is maintained.

2.2 Special versions

For special versions, which are not listed in the order code below 2.1, these specifications apply accordingly, provided that they correspond to the standard version.

2.3 Purpose

The solenoid interlock has been designed to prevent in conjunction with the control part of a machine, movable safety guards from being opened before hazardous conditions have been eliminated. The AZM 170 I solenoid interlocks with individual coding offer a higher protection against tampering.



The safety switchgear units are classified as type 2 interlocking devices in accordance with EN ISO 14119 and are rated as highly coded.



Interlocks with power to lock principle may only be used in special cases after a thorough evaluation of the accident risk, since the safety guard can be opened immediately on failure of the power supply or upon activation of the main switch.

Manual release

A manual release is available as a mounting tool and in the event of a power failure in case the power to unlock principle is used. If the triangular key is turned 180°, the locking bolt is pulled into the unlocking position. Please ensure that jamming by external influence on the actuator is avoided. The normal locking function is only restored after the triangular key has been returned to its original position. After being put into operation, the manual release must be secured by installing the sealing plug, which is included in delivery.

Manual release

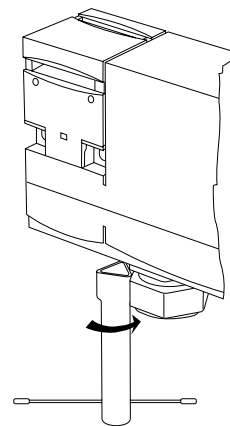

Manual release from side

Ordering suffix -2197 or ST

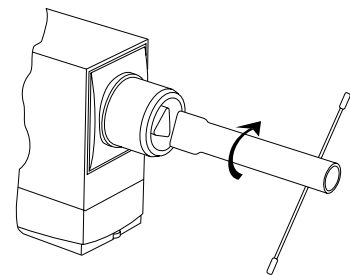

Triangular key TK-M5 (101100887) available as accessory.

Emergency exit

Fitting and actuation only from within the hazardous area.

To activate the emergency exit, turn the red lever in the direction of the arrow to the end stop. Please ensure that jamming by external influence on the actuator is avoided.



The user must evaluate and design the safety chain in accordance with the relevant standards and the required safety level.



The entire concept of the control system, in which the safety component is integrated, must be validated to the relevant standards.

2.4 Technical data

Standards:	EN 60947-5-1, EN ISO 14119
Enclosure:	glass-fibre reinforced thermoplastic, self-extinguishing
Actuator and locking bolt:	stainless steel 1.4301
Holding force F_{max} :	1,300 N
Holding force F_{Zh} :	1,000 N
Latching force:	5 N
- Ordering suffix R:	30 N
Coding level according to EN ISO 14119:	high
Degree of protection:	IP67
Contact material:	Silver
Contact type:	change-over contact with double break, type Zb or 2 NC contacts, with galvanically separated contact bridges
Switching system:	⊖ EN 60947-5-1, slow action, NC contact with positive break
Connection:	Cut clamps, screw terminals or M12 connector
Cable entry:	M20 x 1.5
Cable type:	multi-wire or single-wire
Cable section:	
- Cut clamps:	0.75 ... 1.0 mm ²
- Screw terminals:	0.25 ... 1.5 mm ² (incl. insulated conductor ferrules)
Ambient temperature:	-25 °C ... +60 °C
Positive break travel (unlocked):	11 mm
Positive break force (unlocked):	8.5 N for each NC contact fitted
Actuating speed:	max. 2 m/s
Actuating frequency:	max. 1,000 operations/h
Mechanical life:	> 1,000,000 operations

Electrical data

Utilisation category:	DC-13
- -11 or -02 versions:	AC-15, DC-13
Rated operating current/voltage I_e/U_e :	
- Cut clamps, Screw terminals:	4 A / 230 VAC 2.5 A / 24 VDC
- Connector 4-pole:	4 A / 230 VAC 4 A / 24 VDC
- Connector 8-pole:	2 A / 24 VDC
Rated impulse withstand voltage U_{imp} :	
- Cut clamps, Screw terminals:	4 kV
- Connector 4-pole:	2.5 kV
- Connector 8-pole:	0.8 kV
Rated insulation voltage U_i :	
- Cut clamps, Screw terminals:	250 V
- Connector 4-pole:	250 V
- Connector 8-pole:	60 V
Thermal test current I_{the} :	
- Cut clamps, Screw terminals:	6 A
- Connector 4-pole:	4 A
- Connector 8-pole:	2 A
Max. fuse rating:	
- Cut clamps, Screw terminals:	6 A gG D-fuse
- Connector 4-pole:	4 A gG D-fuse
- Connector 8-pole:	2 A gG D-fuse
Required rated short-circuit current:	1,000 A
Rated control voltage U_s :	24 VDC 24 VAC / 50/60 Hz 110 VAC / 50/60 Hz 230 VAC / 50/60 Hz

Electrical data – Magnet control

Magnet switch-on time:	100 %
Power consumption:	max. 12 W
Accepted test pulse duration on input signal:	≤ 5.0 ms
- With test pulse interval of:	≥ 50 ms

2.5 Safety classification of the interlocking function

Standards:	EN ISO 13849-1
Envisaged structure:	
- Basically:	applicable up to Cat. 1 / PL c
- With 2-channel usage and fault exclusion mechanism*:	applicable up to Cat. 3 / PL d with suitable logic unit
B_{10D} NC contact:	2,000,000
B_{10D} NO contact at 10% ohmic contact load:	1,000,000
Mission time:	20 years

* If a fault exclusion to the 1-channel mechanics is authorised.

$$MTTF_D = \frac{B_{10D}}{0,1 \times n_{op}} \quad n_{op} = \frac{d_{op} \times h_{op} \times 3600 \text{ s/h}}{t_{cycle}}$$

(Determined values can vary depending on the application-specific parameters h_{op} , d_{op} and t_{cycle} as well as the load.)

If multiple safety components are wired in series, the Performance Level to EN ISO 13849-1 will be reduced due to the restricted error detection under certain circumstances.

2.6 Safety classification of the guard locking function

If the device is used as an interlock for personal safety, a safety classification of the guard locking function is required. When classifying the interlock function, a distinction must be made between monitoring of the interlock function (locking function) and controlling the unlocking function.

The following safety classification of the unlocking function is based on the application of the principle of safety energy disconnection for the solenoid supply



The classification of the release function is only valid for devices with monitored guard locking function and in the power to unlock version (see ordering code).

A fault exclusion for the guard locking function can be assumed by an external safety energy disconnection.

In this case, the guard locking function does not have an effect on the failure probability of the unlock function.

The safety level of the unlock function is determined exclusively by the external safety power shutdown.

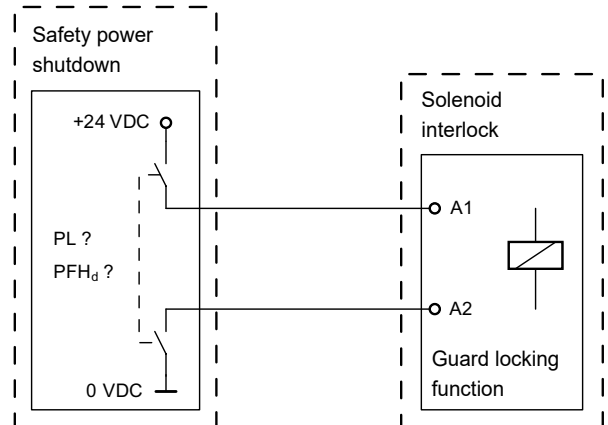

Fault exclusion with regard to wiring routing must be observed.



If for a certain application the power to unlock version of a solenoid interlock cannot be used, for this exception an interlock with power to lock can be used if additional safety measure need to be realised that have an equivalent safety level.

3. Mounting

3.1 General mounting instructions



On delivery, the actuator is in inserted condition. For power-to-unlock components, the actuator must be released by means of the manual release. On delivery, the actuator is in inserted condition. For power-to-unlock components, the actuator must be released by means of the manual release. If the triangular key is turned 180°, the locking bolt is pulled into the unlocking position. The normal locking function is only restored after the triangular key has been returned to its original position.

Two mounting holes are provided for fixing the enclosure. The solenoid interlock is double insulated. The use of an earth wire is not authorised. The solenoid interlock must not be used as an end stop. Any mounting position. The mounting position must be chosen so as to avoid the penetration of dirt in the used holes. The unused opening must be sealed by means of slot sealing plugs. Tightening force for the Torx T10 cover screws 0.7 ... 1 Nm.



Please observe the remarks of the standards EN ISO 12100, EN ISO 14119 and EN ISO 14120.



The actuator must be permanently fitted to the safety guards and protected against displacement by suitable measures (tamperproof screws, gluing, drilling of the screw heads).

3.2 Dimensions

All measurements in mm.

AZM 170 with cut clamps and cable glands

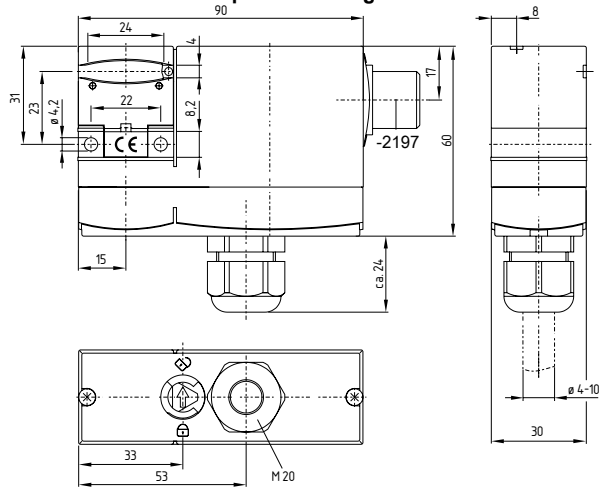

AZM 170SK with screw terminals and cable glands

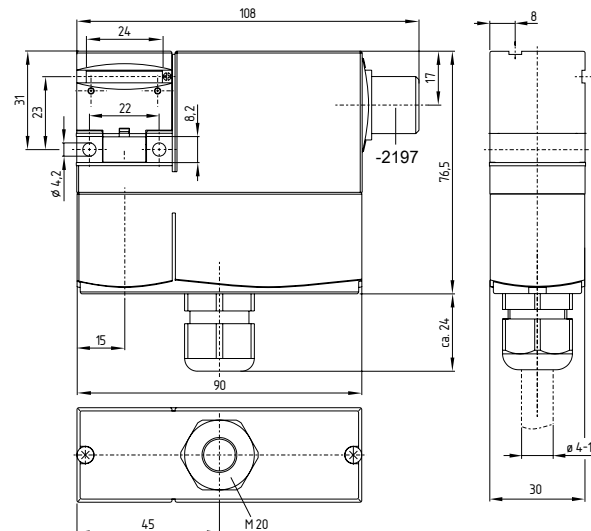

Key: Manual release from side with ordering suffix -2197

AZM 170...-ST with connectors, 2 x 4 poles, A- or B-coding

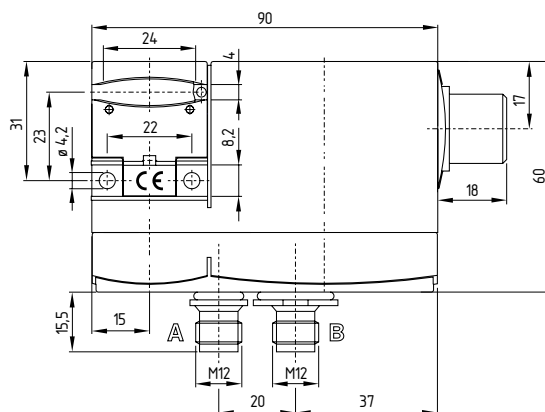

AZM 170ST with connectors, 1x 4 poles, 1 x 8 poles

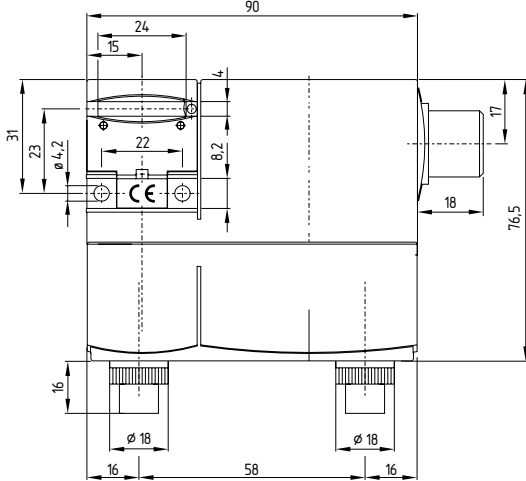

Actuator

Straight actuator B1

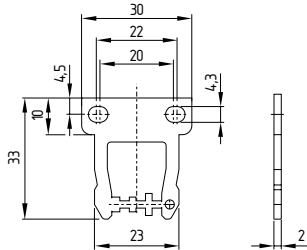

Angled actuator B5

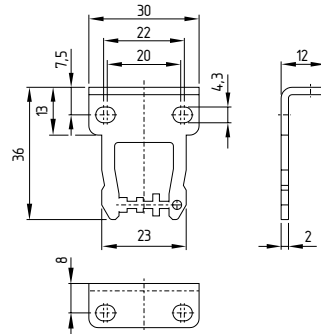

Flexible actuator B6L

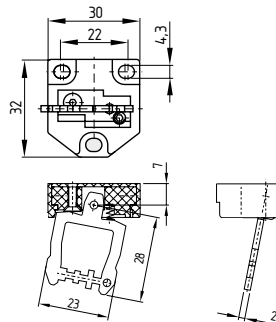

Flexible actuator B6R

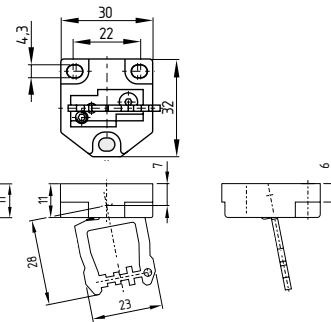

Mounting of the actuator



The marks on the used actuator opening of the solenoid interlock and on the actuator must be opposite.

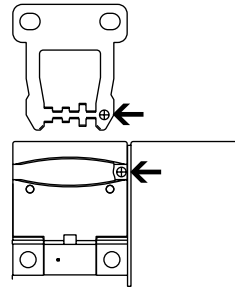

Please observe that, when fixing the switch e.g. by means of rivetting or welding, the insertion depth of the actuator is not modified. Different actuator forms are available. The actuators B1 and B5 are preferably used for sliding and removable safety guards. For hinged guards, the B6R and B6L actuators.

When the switch is fitted on a hinged safety guard, please ensure that the point of rotation is located within the range of the upper surface of the safety switch, in which the actuator hook is inserted (refer to table).

	Actuating radii					
	R_{min} [mm]	d [mm]	R_{min} [mm]	d [mm]	R_{min} [mm]	d [mm]
	B6L	50	11	50	11	
	B6R	50	11	50	11	
	B1	-	-	-	-	
	B5	-	-	-	-	

Key

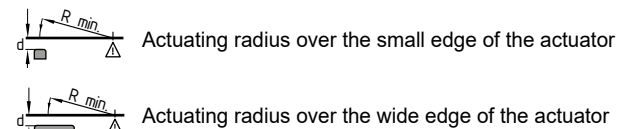

The axis of the hinge must be d mm above and in a parallel plane to the top surface of the safety switch. The basis setting provides a minimum radius of R_{min} .

Actuator B6L / B6R

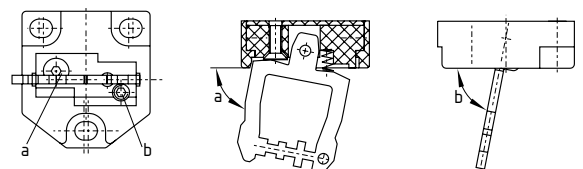

The B6L or B6R actuators are set to the smallest radius in factory. To increase the radius, the setting screws a + b must be turned by means of a hexagonal key A/F 2.5 mm.

4. Electrical connection

4.1 General information for electrical connection



The electrical connection may only be carried out by authorised personnel in a de-energised condition.



If the risk analysis indicates the use of a monitored interlock they are to be connected in the safety circuit with the contacts indicated with the symbol

For the cable entry, suitable cable glands with an appropriate degree of protection must be used.

IDC method of termination

The IDC method of termination (cut clamp technology) enables connecting flexible wires with cable section 0.75 - 1 mm² without using conductor ferrules. To this effect, strip the wire according to the drawing (refer to the wiring example) and insert it into the cable gland, close the cable gland, push the conductors in the groove of the cover (refer to wiring example) and screw the cover back. Observe that the individual conductors remain in position to avoid jamming.

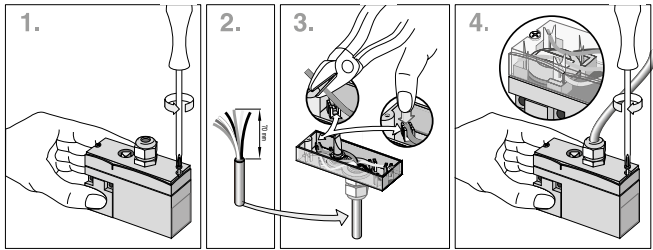

Screw terminals (SK version)

Unscrew the cover of the enclosure. Connect the cables to the terminal block. Use insulated conductor ferrules to that effect. Screw the cover back on the enclosure.

Settle length x of the conductor: 6 mm



Information for the selection of suitable safety-monitoring modules can be found in the Schmersal catalogues or in the online catalogue on our website: products.schmersal.com.

4.2 Contact variants

Contacts shown in a de-energised condition and with the actuator inserted.

AZM 170 I with cut clamps and screw terminals

Power to unlock

1 NO contact 1 NC contact
(Ordering suffix -11)

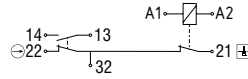

2 NC
(Ordering suffix -02)

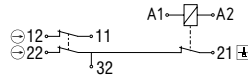

1 NO contact 2 NC contact
(Ordering suffix -12/00)

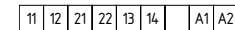
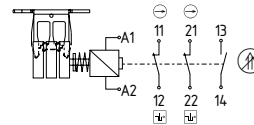

2 NC contact / 1 NC contact
(Ordering suffix -02/01)

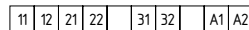
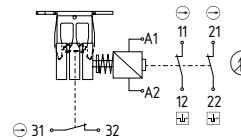

2 NC contact / 1 NO contact
(Ordering suffix -02/10)

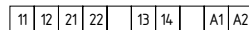
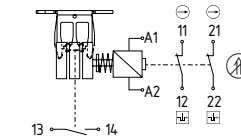

1 NO contact 1 NC contact / 1 NO contact 1 NC contact
(Ordering suffix -11/11)

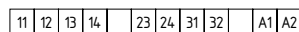
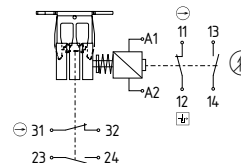

1 NO contact 1 NC contact / 2 NC 1 NO contact 1 NC contact / 2 NC contact
(Ordering suffix -11/02)

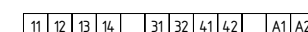
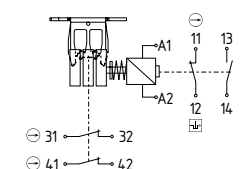

Power to lock

1 NO contact 1 NC contact
(Ordering suffix -11)

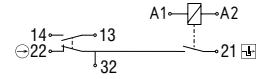

2 NC
(Ordering suffix -02)

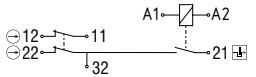

1 NO contact 2 NC contact
(Ordering suffix -12/00)

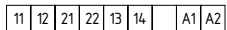
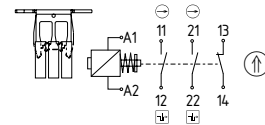

2 NC contact / 1 NC contact
(Ordering suffix -02/01)

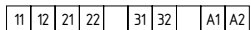
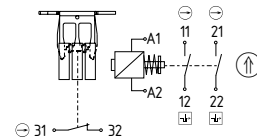

2 NC contact / 1 NO contact
(Ordering suffix -02/10)

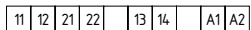
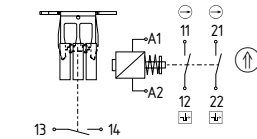

1 NO contact 1 NC contact / 1 NO contact 1 NC contact
(Ordering suffix -11/11)

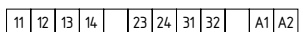
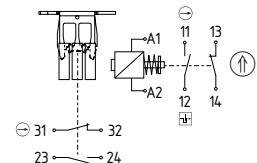

AZM 170 I with connector

Power to unlock

1 NO contact 1 NC contact
(Ordering suffix -11)

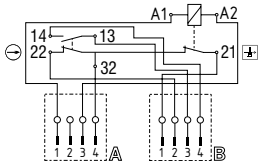

2 NC
(Ordering suffix -02)

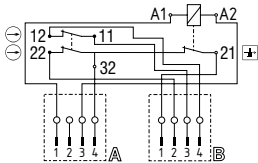

**1 NO contact 2 NC contact /
2 NC contact**
(Ordering suffix -12/02)

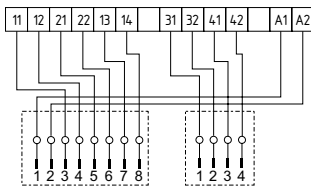
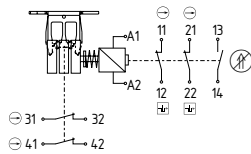

**1 NO contact 2 NC contact /
1 NO contact 1 NC contact**
(Ordering suffix -12/11)

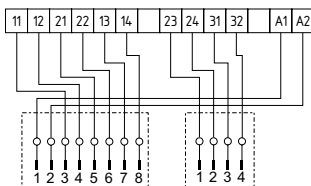
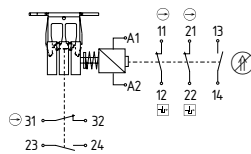

**1 NO contact 1 NC contact /
1 NO contact 1 NC contact**
(Ordering suffix -11/11)

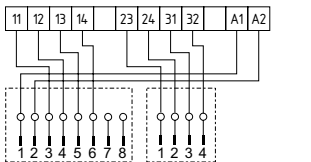
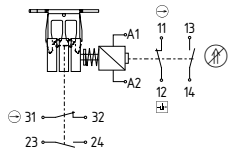

Power to lock

1 NO contact 1 NC contact
(Ordering suffix -11)

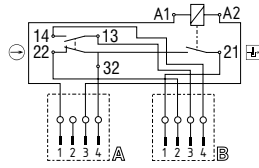

2 NC
(Ordering suffix -02)

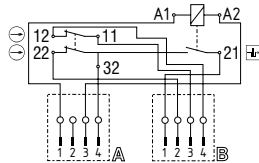

**1 NO contact 2 NC contact /
2 NC contact**
(Ordering suffix -12/02)

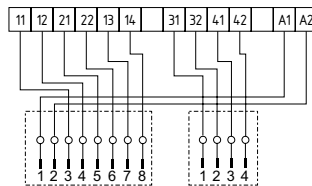
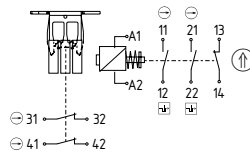

**1 NO contact 2 NC contact /
1 NO contact 1 NC contact**
(Ordering suffix -12/11)

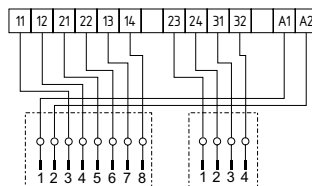
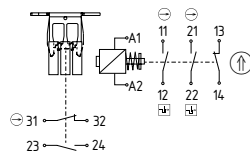

**1 NO contact 1 NC contact /
1 NO contact 1 NC contact**
(Ordering suffix -11/11)

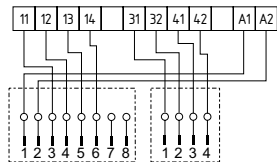
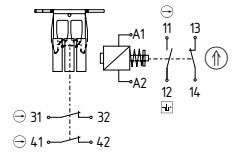

AZM 170 I with connector

Power to unlock

1 NO contact 1 NC contact / 2 NC 1 NO contact 1 NC contact / 2 NC contact
(Ordering suffix -11/02)

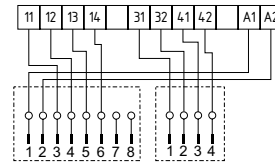
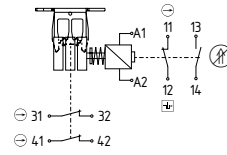

Power to lock

1 NO contact 1 NC contact / 2 NC 1 NO contact 1 NC contact / 2 NC contact
(Ordering suffix -11/02)

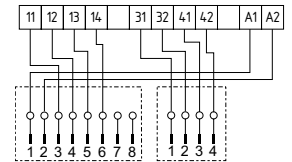
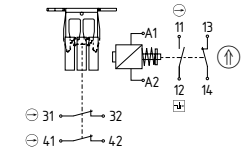

Key

- ⊖ Positive break NC contact
- ⊕ Monitoring the interlock according to EN ISO 14119
- ⊕ Actuated
- ⊖ Not actuated



Information for available connectors can be found on our website: products.schmersal.com.

5. Set-up and maintenance

5.1 Functional testing

The safety function of the safety components must be tested. The following conditions must be previously checked and met:

1. Fitting of the solenoid interlock and the actuator
2. Check the integrity of the cable entry and connections
3. Check the switch enclosure for damage

5.2 Maintenance

A regular visual inspection and functional test, including the following steps, is recommended:

1. Check for tight installation of the actuator and the switch
2. Remove particles of dust and soiling
3. Check cable entry and connections



Adequate measures must be taken to ensure protection against tampering either to prevent tampering of the safety guard, for instance by means of replacement actuators.

Damaged or defective components must be replaced.

6. Disassembly and disposal

6.1 Disassembly

The safety switchgear must be disassembled in a de-energised condition only.

6.2 Disposal

The safety switchgear must be disposed of in an appropriate manner in accordance with the national prescriptions and legislations.

7. EU Declaration of conformity

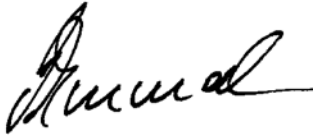
EU Declaration of conformity		 SCHMERSAL
Original	On behalf of K.A. Schmersal GmbH & Co. KG Möddinghofe 30 42279 Wuppertal Germany Internet: www.schmersal.com	
We hereby certify that the hereafter described components both in their basic design and construction conform to the applicable European Directives.		
Name of the component:	AZM 170 I	
Type:	See ordering code	
Description of the component:	Interlocking device with electromagnetic interlock for safety functions	
Relevant Directives:	Machinery Directive	2006/42/EC
	EMC-Directive	2014/30/EU
	RoHS-Directive	2011/65/EU
Applied standards:	EN 60947-5-1:2017 EN ISO 14119:2013	
Person authorised for the compilation of the technical documentation:	Oliver Wacker Möddinghofe 30 42279 Wuppertal	
Place and date of issue:	Wuppertal, August 3, 2020	
		
	Authorised signature Philip Schmersal Managing Director	

AZM170I-D-EN



The currently valid declaration of conformity can be downloaded from the internet at products.schmersal.com.

