



EN Operating instructions. . . . . pages 1 to 6  
Original

**Content**

**1 About this document**

1.1 Function . . . . . 1

1.2 Target group: authorised qualified personnel. . . . . 1

1.3 Explanation of the symbols used . . . . . 1

1.4 Appropriate use . . . . . 1

1.5 General safety instructions . . . . . 1

1.6 Warning about misuse . . . . . 2

1.7 Exclusion of liability . . . . . 2

**2 Product description**

2.1 Ordering code . . . . . 2

2.2 Special versions. . . . . 2

2.3 Purpose . . . . . 2

2.4 Technical data . . . . . 2

2.5 Safety classification . . . . . 2

**3 Mounting**

3.1 General mounting instructions . . . . . 3

3.2 Dimensions . . . . . 3

3.3 Axial misalignment. . . . . 3

3.4 Adjustment. . . . . 4

**4 Electrical connection**

4.1 General information for electrical connection. . . . . 4

4.2 Contact variants. . . . . 4

4.3 Connector plug. . . . . 4

**5 Set-up and maintenance**

5.1 Functional testing. . . . . 5

5.2 Maintenance . . . . . 5

**6 Disassembly and disposal**

6.1 Disassembly. . . . . 5

6.2 Disposal . . . . . 5

**7 EU Declaration of conformity**

**1. About this document**

**1.1 Function**

This operating instructions manual provides all the information you need for the mounting, set-up and commissioning to ensure the safe operation and disassembly of the safety switchgear. The operating instructions must be available in a legible condition and a complete version in the vicinity of the device.

**1.2 Target group: authorised qualified personnel**

All operations described in this operating instructions manual must be carried out by trained specialist personnel, authorised by the plant operator only.

Please make sure that you have read and understood these operating instructions and that you know all applicable legislations regarding occupational safety and accident prevention prior to installation and putting the component into operation.

The machine builder must carefully select the harmonised standards to be complied with as well as other technical specifications for the selection, mounting and integration of the components.

**1.3 Explanation of the symbols used**



**Information, hint, note:**

This symbol is used for identifying useful additional information.



**Caution:** Failure to comply with this warning notice could lead to failures or malfunctions.

**Warning:** Failure to comply with this warning notice could lead to physical injury and/or damage to the machine.

**1.4 Appropriate use**

The products described in these operating instructions are developed to execute safety-related functions as part of an entire plant or machine. It is the responsibility of the manufacturer of a machine or plant to ensure the correct functionality of the entire machine or plant.

The safety switchgear must be exclusively used in accordance with the versions listed below or for the applications authorised by the manufacturer. Detailed information regarding the range of applications can be found in the chapter "Product description".

**1.5 General safety instructions**

The user must observe the safety instructions in this operating instructions manual, the country specific installation standards as well as all prevailing safety regulations and accident prevention rules.



Further technical information can be found in the Schmersal catalogues or in the online catalogue on the Internet: [www.schmersal.net](http://www.schmersal.net).

The information contained in this operating instructions manual is provided without liability and is subject to technical modifications.

There are no residual risks, provided that the safety instructions as well as the instructions regarding mounting, commissioning, operation and maintenance are observed.

### 1.6 Warning about misuse



In case of improper use or manipulation of the safety switch-gear, personal hazards or damages to machinery or plant components cannot be excluded. The relevant requirements of the standard ISO 14119 must be observed.

### 1.7 Exclusion of liability

We shall accept no liability for damages and malfunctions resulting from defective mounting or failure to comply with this operating instructions manual. The manufacturer shall accept no liability for damages resulting from the use of unauthorised spare parts or accessories.

For safety reasons, invasive work on the device as well as arbitrary repairs, conversions and modifications to the device are strictly forbidden; the manufacturer shall accept no liability for damages resulting from such invasive work, arbitrary repairs, conversions and/or modifications to the device.

## 2. Product description

### 2.1 Ordering code

This operating instructions manual applies to the following types:

#### BNS 33-①Z②-③-④

No.	Option	Description
①	02	2 NC
	12	1 NO / 2 NC
②		Without LED
	G	With LED
③		Connecting cable
	ST	Integrated connector M8
	LST	Connecting cable with connector M12
④	2187	Individual contact outlet
	2187-10	Individual contact outlet and LED in NO path
	2363	With connector 1/2"

### 2.2 Special versions

For special versions, which are not listed in the order code below 2.1, these specifications apply accordingly, provided that they correspond to the standard version.

### 2.3 Purpose

The BNS 33-...-2187/-2363 safety sensor is designed for application in safety circuits and is used for monitoring the position of movable safety guards to ISO 14119 and IEC 60947-5-3. To actuate the safety sensors, only the BPS 33 actuators can be used, conventional magnets are not suitable.



The safety switchgears are classified according to ISO 14119 as type 4 switching devices.

The safety switches are used for applications, in which the hazardous situation is terminated without delay when the safety guard is opened.

Only the entire system consisting of the safety sensor (BNS 33-...-2187/-2363), the actuator (BP 33) and the safety-monitoring module (AES/AZR/SRB) meets the requirements of the standard IEC 60947-5-3.



The user must evaluate and design the safety chain in accordance with the relevant standards and the required safety level.



The entire concept of the control system, in which the safety component is integrated, must be validated to the relevant standards.

### 2.4 Technical data

Standards:	IEC 60947-5-3, BG-GS-ET-14
Enclosure:	glass-fibre reinforced thermoplastic
Protection class:	IP67 to IEC 60529
Termination:	LIYY cable or M8 connector
Connecting cable:	
-2187:	LIYY x 6 x 0.25 mm <sup>2</sup> ;
-2363:	6-pole Brad-Harrison connector (screw terminals 1/2")
Version with integrated connector:	M8 x 1, 4-pole
Operating principle:	magnetic
Actuator:	BPS 33, BPS33-2326, coded
Coding level according to ISO 14119:	low
Switching distances:	
- Assured switching distance $s_{ao}$ :	5 mm (BPS 33); 8 mm (BPS 33-2326)
- Assured switch-off distance $s_{ar}$ :	15 mm (BPS 33); 15 mm (BPS 33-2326)
Switching condition indication:	LED only with ordering suffix G
Switching voltage:	
- without LED:	max. 100 VAC/DC
- with LED:	max. 24 VDC
- BNS 33-02ZST-2187:	60 VAC/DC
- BNS 33-12Z-2363:	120 VAC/DC
- BNS 33-02Z-LST-2187:	30 VAC/DC
Switching current:	
- without LED:	max. 250 mA
- with LED:	max. 10 mA
Switching capacity:	
- without LED:	max. 3 W
- with LED:	max. 240 mW
- BNS 33-02ZST-2187:	5 W
Required short-circuit current:	100 A
Ambient temperature:	-25 °C ... +70 °C
Storage and transport temperature:	-25 °C ... +70 °C
Max. switching frequency:	approx. 1 Hz
Resistance to shock:	30 g / 11 ms
Resistance to vibration:	10 ... 55 Hz, amplitude 1 mm

### 2.5 Safety classification

Standards:	ISO 13849-1
Safety contacts:	
- NC / NC combination:	S11-S12 and S21-S22 or S21-S22 and S31-S32
Intended structure:	
- 2-channel usage:	usable to cat. 4 / PL e with suitable logic unit
$B_{10D}$ NC contacts at 20 % contact load:	25.000.000
Service life:	20 years

$$MTTF_D = \frac{B_{10D}}{0,1 \times n_{op}} \quad n_{op} = \frac{d_{op} \times h_{op} \times 3600 \text{ s/h}}{t_{cycle}}$$

(Determined values can vary depending on the application-specific parameters  $h_{op}$ ,  $d_{op}$  and  $t_{cycle}$  as well as the load.)

If multiple safety components are wired in series, the Performance Level to ISO 13849-1 will be reduced due to the restricted error detection under certain circumstances.



### 3.4 Adjustment

The LED of the BNS 33 variants can only be used as a rough setting tool. The correct functionality of both safety channels must be checked by means of the connected safety-monitoring module.



#### Recommended Adjustment

Align the safety sensor and actuator at a distance of  $0.5 \times s_{a0}$ .

## 4. Electrical connection

### 4.1 General information for electrical connection



The electrical connection may only be carried out by authorised personnel in a de-energised condition.

The safety sensors must be wired in accordance with the wire colours or the pin configuration.

The proper functioning must always be checked by means of the connected safety-monitoring module.

### 4.2 Contact variants

The contact position shows the actuated sensor function when the safety guard is closed. For safety sensors with LED, the LED is illuminated when the safety guard is closed.

Safety contacts: 02Z: S11-S12 and S21-S22  
12Z: S21-S22 and S31-S32  
Signalling contact: 12Z: S13-S14

#### BNS 33-02Z-2187      BNS 33-02ZG-2187

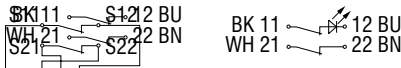

#### BNS 33-02ZST-2187      BNS 33-02ZGST-2187

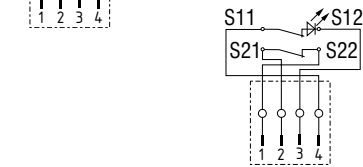

#### BNS 33-12Z-2187      BNS 33-12ZG-2187      BNS 33-12ZG-2187-10

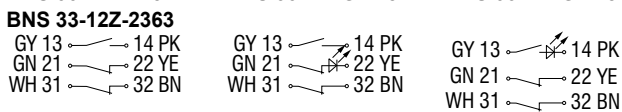

#### BNS 33-12Z-LST-2187

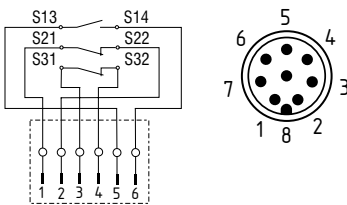

#### BNS 33-12Z-2363

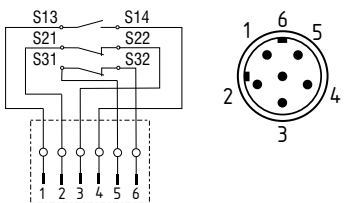

Information for the selection of suitable safety-monitoring modules can be found in the Schmersal catalogues or in the online catalogue on the Internet: [www.schmersal.net](http://www.schmersal.net).

Connecting multiple BNS 33-2ZG-2187/-2363BNS 260-11z safety sensors to one safety-monitoring module is possible. In this configuration, all safety-relevant NC contacts are wired in series (check if authorised).

Safety sensors equipped with a LED however shall not be wired in series. If the LED's of the series-wired safety sensors are in the NC paths, the luminosity of the LED's is highly reduced and the increased voltage drop will possibly cause the voltage dropping below the minimum input voltage of the downstream safety-monitoring module.

### 4.3 Connector plug

#### Integrated connector M8, 4-pole

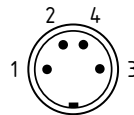

#### Accessories: connecting cable with coupling

M8, 4-pole			2 m	5 m
	1	BN	straight	1209947
	2	WH		
	3	BU	angled	1210557
	4	BK		

#### Accessory: Y-adaptor BNS-Y-02

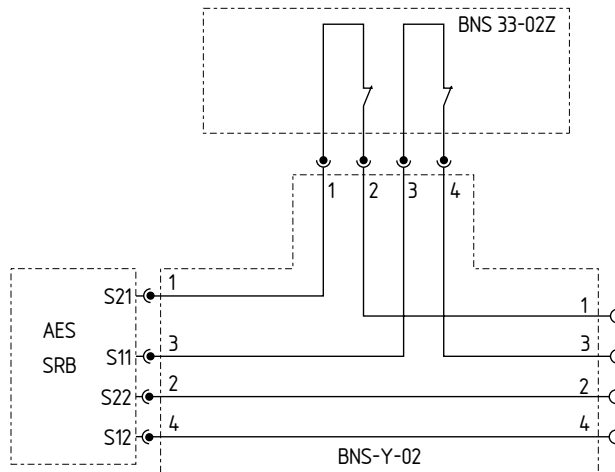

## 5. Set-up and maintenance

### 5.1 Functional testing

The safety function of the safety components must be tested. The following conditions must be previously checked and met:

1. Fitting of the sensor and the actuator
2. Fitting and integrity of the power cable
3. The system is free of dirt and soiling (in particular metal chips)

### 5.2 Maintenance

In the case of correct installation and adequate use, the safety sensor features maintenance-free functionality. A regular visual inspection and functional test, including the following steps, is recommended:

- Check the fitting of the sensor and the actuator
- Remove possible metal chips
- Check the cable for damage.



Adequate measures must be taken to ensure protection against tampering either to prevent tampering of the safety guard, for instance by means of replacement actuators.

**Damaged or defective components must be replaced.**

## 6. Disassembly and disposal

### 6.1 Disassembly

The safety switchgear must be disassembled in a de-energised condition only.

### 6.2 Disposal

The safety switchgear must be disposed of in an appropriate manner in accordance with the national prescriptions and legislations.

7. EU Declaration of conformity

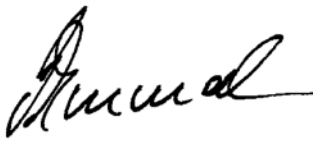
<b>EU Declaration of conformity</b>		
Original	K.A. Schmersal GmbH & Co. KG Möddinghofe 30 42279 Wuppertal Germany Internet: www.schmersal.com	
We hereby certify that the hereafter described components both in their basic design and construction conform to the applicable European Directives.		
<b>Name of the component:</b>	BNS 33	
<b>Type:</b>	See ordering code	
<b>Description of the component:</b>	Safety-sensor with magnetic operating principle in combination with the AES / AZR / SRB safety-monitoring modules from Schmersal or an equivalent safety-oriented control system fulfilling the requirements of the DIN EN 60947-5-3.	
<b>Relevant Directives:</b>	Machinery Directive RoHS-Directive	2006/42/EG 2011/65/EU
<b>Applied standards:</b>	DIN EN 60947-5-3: 2014, DIN EN ISO 14119: 2014	
<b>Person authorised for the compilation of the technical documentation:</b>	Oliver Wacker Möddinghofe 30 42279 Wuppertal	
<b>Place and date of issue:</b>	Wuppertal, March 2, 2016	
		
	Authorised signature <b>Philip Schmersal</b> Managing Director	

BNS33-F-EN



The currently valid declaration of conformity can be downloaded from the internet at [www.schmersal.net](http://www.schmersal.net).



**K. A. Schmersal GmbH & Co. KG**  
Möddinghofe 30, D - 42279 Wuppertal  
Postfach 24 02 63, D - 42232 Wuppertal

Phone: +49 - (0)2 02 - 64 74 - 0  
Telefax: +49 - (0)2 02 - 64 74 - 1 00  
E-Mail: [info@schmersal.com](mailto:info@schmersal.com)  
Internet: <http://www.schmersal.com>