

WLC60XW340GAR

Work Light

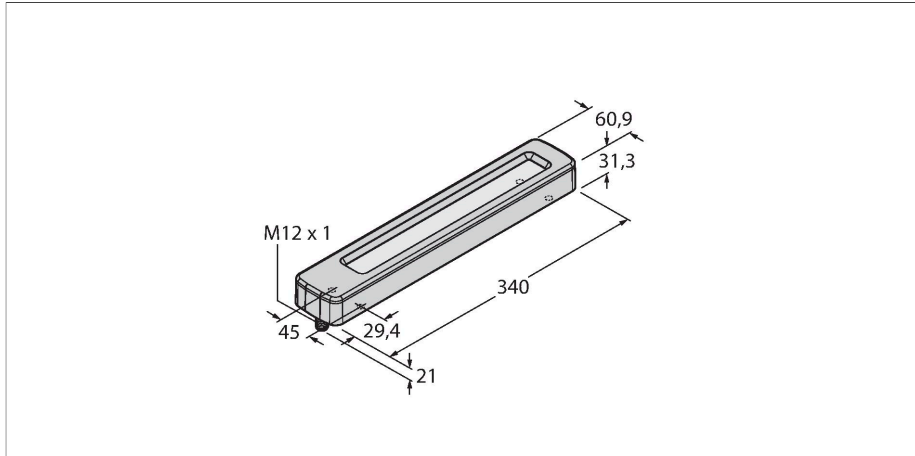

Features

- Operating voltage: 12...30 VDC
- Protection class IP67/IP69K
- Ambient temperature: -40 °C...+70 °C
- Window material: borosilicate glass
- Housing length: 340 mm
- Monochrome: Cold white
- High protection classes IP67 / IP69K
- Cable, 2 m, 4-pin, rear outlet

Wiring diagram

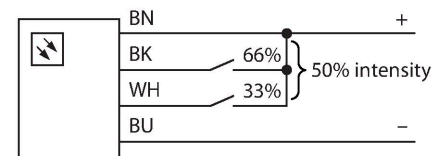

Technical data

Type	WLC60XW340GAR
ID	3086872
Signal and display data	
Purpose	LED work light
Function	Linear light
Light type	White
Color temperature	5650...+6700 K
Luminous flux lumen	1300 lm
LED service life (L70)	50000 h
Dimmable	Two-stage
Features of color 1	White, Permanently on, 1300 lm
Special features	Chemical-resistant Wash down Resistant to chemicals
Electrical data	
Operating voltage	12...30 VDC
DC rated operational current	≤ 1.4 mA
Input power	16.8 W
Mechanical data	
Cascadable	No
Design	Rectangular, WLC60
Dimensions	339.9 x 60.9 x 46 mm
Housing material	Metal, Nickel-plated aluminum
Window material	Glass, clear
Electrical connection	Cable, 2 m, PVC
Number of cores	4
Ambient temperature	-40...+70 °C

Functional principle

The energy-efficient LED work lights are ideally suited for industrial applications. The color temperature lies in the range of daylight, between 6,000 and 7,100 Kelvin. Depending on the model, the luminous flux is 1,300 or 2,600 lumen. The WLC60 series withstands the toughest environmental conditions and offers a high brightness. Cascadable variants are also available.

