

QMT42VN6FF750Q

Photoelectric Sensor – Diffuse Mode Sensor with Fixed-Field Background Suppression

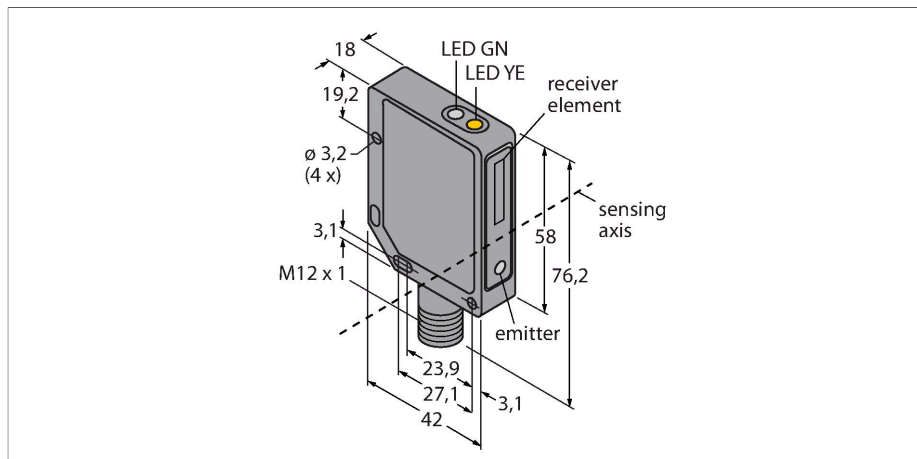

Features

- Male M12 × 1, 4-pin
- Metal housing, ZN, black
- Protection class IP67
- Operating voltage 10...30 VDC
- NPN switching output
- Light/dark operation

Wiring diagram

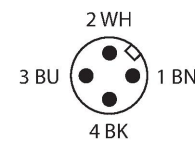
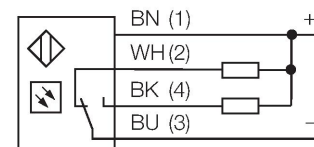

Technical data

Type	QMT42VN6FF750Q
ID no.	3057542
Optical data	
Function	Proximity switch
Operating mode	Background suppression, non-adjustable
Light type	IR
Wavelength	880 nm
Range	50...750 mm
Electrical data	
Operating voltage	10...30 VDC
Residual ripple	< 10 % U _{ss}
DC rated operational current	≤ 100 mA
No-load current	≤ 50 mA
Short-circuit protection	yes
Reverse polarity protection	yes
Output function	NO/NC, NPN
Switching frequency	≤ 500 Hz
Readiness delay	≤ 100 ms
Response time typical	< 1 ms
Overcurrent release	> 150 mA
Mechanical data	
Design	Rectangular, QMT42
Dimensions	42 x 18 x 76.2 mm
Housing material	Metal, Die-cast zinc alloy, Black-finished
Lens	plastic, Acrylic
Electrical connection	Connectors, M12 × 1, PVC

Functional principle

Diffuse mode sensors with background suppression operate with a single emitter and several receiver elements. The target position and the photoelectric structure of the sensor determine which of the receiving elements receives the most light. The sensor electronics determine whether the reflecting object is within or outside the measuring range. These sensors come with a fixed cut-off point.

Excess gain curve
Excess gain in relation to the distance

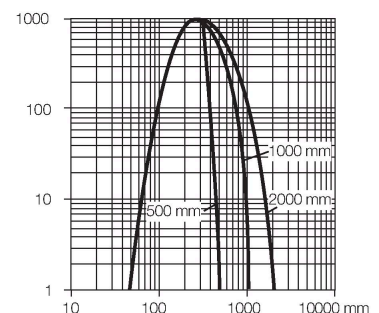

Technical data

Number of cores	4
Ambient temperature	-20...+55 °C
Protection class	IP67
Power-on indication	LED, Green
Switching state	LED, Yellow
Error indication	LED, green, Flashing
Excess gain indication	LED
Alarm display	LED yellow Flashing
Tests/approvals	
Approvals	CE, cURus

Accessories

SMB30SK

3052523

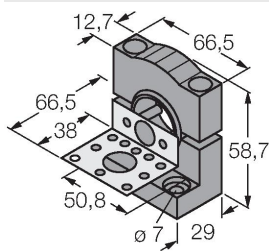

Mounting bracket, PBT black, with mounting plate, stainless steel, for types with 18 mm thread, QM42/ QMT42

SMB46S

3048748

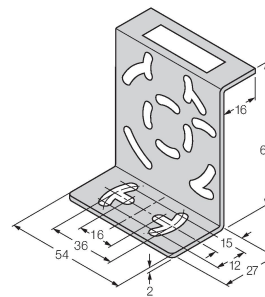

Mounting bracket, stainless steel, for QS18, QS30, MINI-BEAM, QM42/ QMT42

SMB46L

3048747

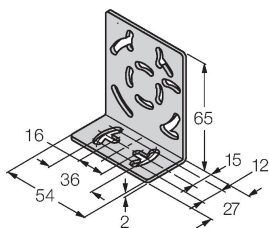

Mounting bracket, stainless steel, for QS18, QS30, MINI-BEAM, QM42/ QMT42