

BI12-M30-AD4X-H1141

Inductive Sensor

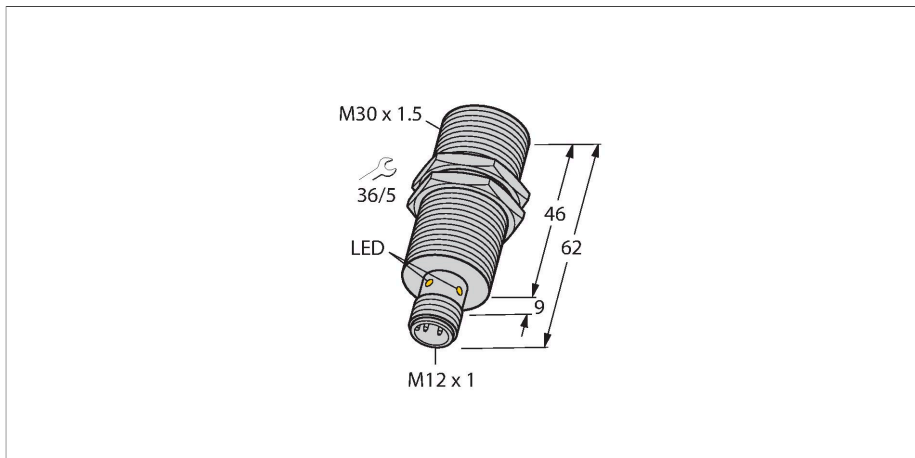

Technical data

Type	BI12-M30-AD4X-H1141
ID	4417041
General data	
Rated switching distance	12 mm
Mounting conditions	Flush
Secured operating distance	$\leq (0.81 \times S_n)$ mm
Correction factors	St37 = 1; Al = 0.3; stainless steel = 0.7; Ms = 0.4
Repeat accuracy	≤ 2 % of full scale
Temperature drift	$\leq \pm 10$ %
Hysteresis	1...15 %
Electrical data	
Operating voltage	10...65 VDC
Residual ripple	≤ 10 % U_{ss}
DC rated operational current	≤ 100 mA
Residual current	≤ 0.6 mA
Isolation test voltage	≤ 0.5 kV
Short-circuit protection	yes / Cyclic
Voltage drop at I_a	≤ 5 V
Wire breakage/Reverse polarity protection	Complete
Output function	2-wire, NO contact, 2-wire
Smallest operating current	≥ 3 mA
Switching frequency	0.5 kHz
Mechanical data	
Design	Threaded barrel, M30 x 1.5
Dimensions	62 mm
Housing material	Metal, CuZn, Chrome-plated

Features

- M30 × 1.5 threaded tube
- Chrome-plated brass
- DC 2-wire, 10...65 VDC
- NO contact
- M12 x 1 male connector

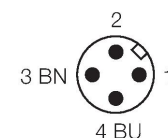
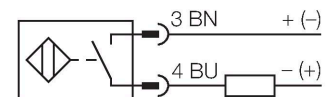

Functional principle

Inductive sensors detect metal objects contactless and wear-free. For this, they use a high-frequency electromagnetic AC field that interacts with the target. Inductive sensors generate this field via an RLC circuit with a ferrite coil.

Technical data

Active area material	Plastic, PA12-GF30
Max. tightening torque of housing nut	75 Nm
Electrical connection	Connector, M12 × 1
Environmental conditions	
Ambient temperature	-25...+70 °C
Vibration resistance	55 Hz (1 mm)
Shock resistance	30 g (11 ms)
Protection class	IP67
MTTF	2283 years acc. to SN 29500 (Ed. 99) 40 °C
Switching state	LED, Yellow

Mounting instructions

Mounting instructions/Description



Distance D	2 x B
Distance W	3 x Sn
Distance T	3 x B
Distance S	1.5 x B
Distance G	6 x Sn
Diameter active area B	Ø 30 mm

Accessories

BST-30B

6947216



Mounting clamp for threaded barrel sensors, with dead-stop; material: PA6

QM-30

6945103

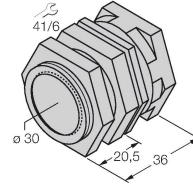

Quick-mount bracket with dead-stop; material: Chrome-plated brass. Male thread M36 × 1.5. Note: The switching distance of the proximity switches may change when using quick-mount brackets.

MW-30

6945005



Mounting bracket for threaded barrel sensors; material: Stainless steel A2 1.4301 (AISI 304)

BSS-30

6901319



Mounting clamp for smooth and threaded barrel sensors; material: Polypropylene

Accessories

Dimension drawing

Type

ID

RKC4T-2/TEL

6625010

Connection cable, M12 female connector, straight, 3-pin, cable length: 2 m, jacket material: PVC, black; cULus approval

