

VC9S22-T80E-1-WSC5.31T/TEL

Valve connector CI type – Extension Cable

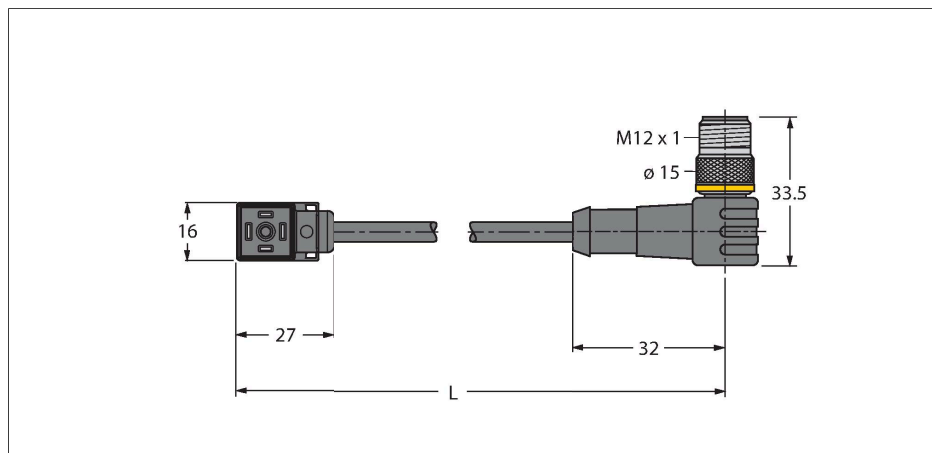

Features



- 2-pin + PE, bridged
- Design according to the DIN EN 175301-803
- RoHS-compliant
- Protection class: IP65, IP67, IP68
- Protective component: Z-diode
- M12 male, angled, 2-pin + PE
- Sheath material: PVC
- Sheath color: black
- Resistant to chemicals and oils
- Flame retardant
- Resistant to acids and alkaline solutions
- Resistant to microbes and hydrolysis
- LABS-free
- Cable length: 1.0 m

Technical data

Type	VC9S22-T80E-1-WSC5.31T/TEL
ID	6606938
Connector A	Valve connector, Design CI
Number of Pins	2+PE, PE bridged
Contacts	Metal, CuSn, Silver-plated
Contact carriers	Plastic, PA, Black
Connector body	Plastic, TPU, Black/Translucent
Protective component	Z diode
Seal	Plastic, TPU
Display switch state	LED, Yellow/yellow
Mechanical lifespan	> 100 Mating cycles
Pollution degree	3
Protection class	IP65, IP67, IP68, (mounted)
Connector B	Male, M12 × 1, Angled
Number of pins	2+PE
Contacts	Metal, CuZn, Gold-plated
Contact carriers	Plastic, TPU, Black
Connector body	Plastic, TPU, Black
Coupling nut/retaining screw	Brass, CuZn, Nickel-plated
Tightening torque	0.8 ... 1 Nm
Mechanical life	> 100 Mating cycles
Pollution degree	3
Protection class	IP67, IP69K, Only when screwed together
Cable diameter	Ø 5.3 mm ±0.20
Cable length	1 m
Cable jacket	PVC, Black
Core insulation	PVC

Contact assignment

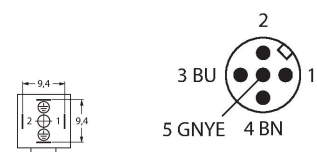

Circuit Diagram

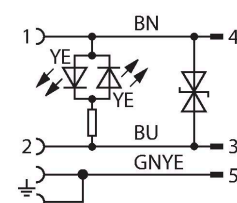

Technical data

Core cross-section	3 x 0.34 mm ²
Arrangement of strands	19 x 0.15 mm
Core colors	BN, BU, GNYE
Electrical properties at +20 °C	
Rated voltage	24 V
Test voltage	2000 V
Current	4 A
Insulation resistance	> 1 MΩ/km
Insulation resistance	≥ 10 ⁸ Ω
forward resistance	max. 57 Ω/km
Mechanical and chemical properties	
Bending radius (stationary installation)	≥ 5 x Ø
Bending radius (flexible use)	≥ 10 x Ø
Ambient temperature range (stationary)	-40...+105 °C
Ambient temperature range (In motion)	0...+80 °C
Mounting screw	Brass, CuZn, nickel-plated