

# RSC4.4T-0.3/TXO3700

## Actuator and Sensor Cable, PUR – Connection Cable

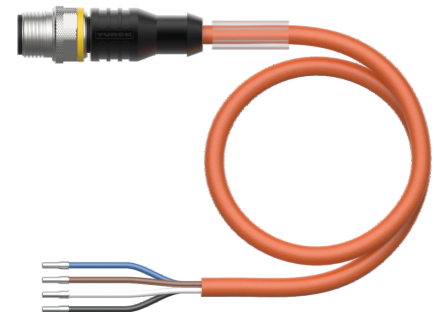
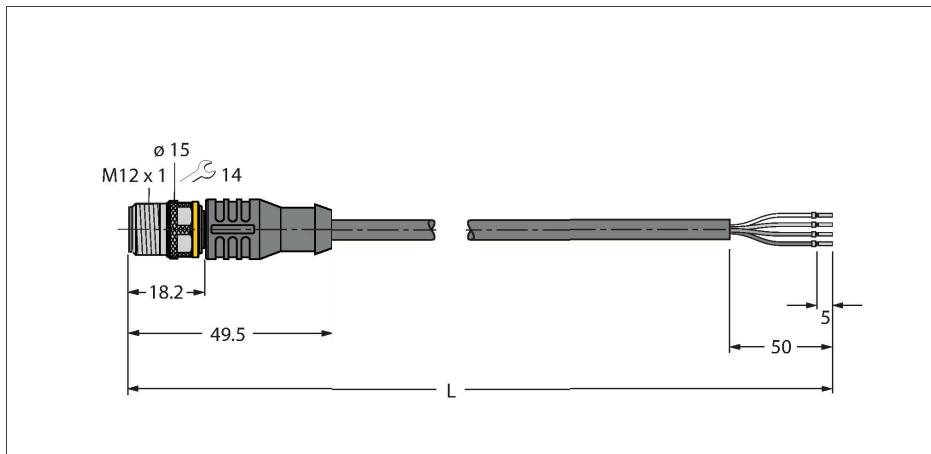

### Technical data

Type	RSC4.4T-0.3/TXO3700
ID	6633481
Connector A	Male, M12 × 1, Straight, A-coded
Number of Pins	4
Contacts	Brass, CuZn, Gold-plated
Contact carriers	Plastic, TPU, Black
Connector body	Plastic, TPU, Black
Coupling nut/screw	Brass, CuZn, Nickel-plated
Mechanical lifespan	> 100 Mating cycles
Pollution degree	3
Protection class	IP67, IP69K, Only in screwed condition
<b>Cable</b>	
Cable diameter	Ø 6.7 mm ±0.20
Cable length	0.3 m
Cable jacket	PUR, Orange
Core insulation	PP
Core cross-section	4 x 0.34 mm <sup>2</sup>
Arrangement of strands	42 x 0.1 mm
Core colors	BN, WH, BU, BK
<b>Electrical properties at +20 °C</b>	
Rated voltage	250 V
Test voltage	2000 V
Current	4 A
Insulation resistance	> 30.5 MΩ/km
forward resistance	max. 57 Ω/km
<b>Mechanical and chemical properties</b>	
Bending radius (stationary installation)	≥ 5 x Ø

### Features



- Male M12, straight, 4-pin
- Jacket material: PUR
- Jacket color: orange
- Suitable for drag chain use
- Resistant to welding sparks
- Resistant to chemicals, UV radiation and oils
- Flame retardant (FT2 acc. to UL 1581, IEC 60332-2-2)
- Free from halogen, silicone, PVC and LABS
- Particularly resistant to abrasion
- Protection class: IP67, IP69K
- Cable length: 0.3 m

### Contact assignment

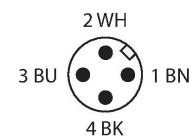

### Circuit Diagram



## Technical data

Bending radius (flexible use)	$\geq 10 \times \varnothing$
Bending cycles	$\geq 5$ million
Admissible acceleration	max. 5 m/s <sup>2</sup>
Admissible travel path, horizontal	5 m (at 5 m/s <sup>2</sup> )
Admissible travel path, vertical	2 m (at 5 m/s <sup>2</sup> )
Admissible traversing speed	3.3 m/s
Torsional stress	$\pm 180$ °/m
Ambient temperature range (stationary)	-50...+80 °C
Ambient temperature range (In motion)	-25...+80 °C
Ambient temperature during drag chain operation	-25...+60 °C
Approvals	cULus

## Accessories

### TORQUE-WRENCH-SET-AS 6936170

Torque wrench set; handles with adjustable torque 0.4-1.0 Nm, torque wrench for M8 (SW9), fork wrench for M12 (SW 14)

### HA8141-0 6905407

Field-wireable female connector, M12 × 1, straight, 4-pin, insulation piercing connection, cable feedthrough 4.0 to 5.1 mm, core cross-section/terminal capacity 0.14 to 0.34 mm<sup>2</sup>, plastic housing, metal nut

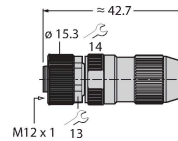

### HA8241-0 6905401

Field-wireable female connector, M12 × 1, angled, 4-pin, insulation piercing connection, cable feedthrough 4.0 to 5.1 mm, core cross-section/terminal capacity 0.14 to 0.34 mm<sup>2</sup>, plastic housing, metal nut

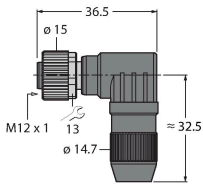

### B8141-0 69049

Field-wireable female connector, M12 × 1, straight, 4-pin, screw terminal connection, cable feedthrough 4.0 to 6.0 mm, core cross-section/terminal capacity 0.14 to 0.75 mm<sup>2</sup>, plastic housing, plastic nut

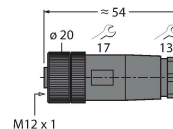

### B8241-0 69048

Field-wireable female connector, M12 × 1, angled, 4-pin, screw terminal connection, cable feedthrough 4.0 to 6.0 mm, core cross-section/terminal capacity 0.14 to 0.75 mm<sup>2</sup>, plastic housing, plastic nut

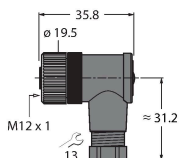

### BM8141-0 6935145

Field-wireable female connector, M12 × 1, straight, 4-pin, screw terminal connection, cable feedthrough 4.0 to 6.0 mm, core cross-section/terminal capacity 0.25 to 0.75 mm<sup>2</sup>, plastic housing, metal nut

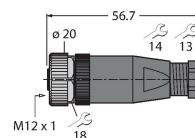

BM8241-0

6935889

Field-wireable female connector, M12 × 1, angled, 4-pin, screw terminal connection, cable feedthrough 4.0 to 6.0 mm, core cross-section/terminal capacity 0.25 to 0.75 mm<sup>2</sup>, plastic housing, metal nut

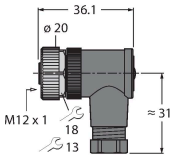

FW-ERKPM0426-SA-P-0408

10002047

Field-wireable female connector, M12 × 1, straight, 4-pin, push-in connection, cable feedthrough 4.0 to 8.0 mm, core cross-section/terminal capacity 0.14 to 0.75 mm<sup>2</sup>, plastic housing, metal coupling nut

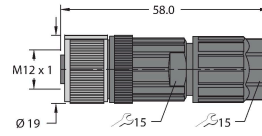

FW-ERKPM0416-SA-S-0408

10002283

Field-wireable female connector, M12 × 1, straight, 4-pin, screw terminal connection, cable feedthrough 4.0 to 8.0 mm, core cross-section/terminal capacity 0.25 to 1.5 mm<sup>2</sup>, plastic housing, metal nut

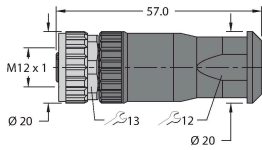

FW-EWKPM0416-SA-S-0408

10002286

Field-wireable female connector, M12 × 1, angled, 4-pin, screw terminal connection, cable feedthrough 4.0 to 8.0 mm, core cross-section/terminal capacity 0.25 to 1.5 mm<sup>2</sup>, plastic housing, metal nut

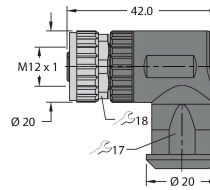

## Accessories

Dimension drawing

Type

ID

LABEL-HOLDER-FLEX-PVC

100048170

PVC label holder for identification of extension cables (TEL/TXL product series); for cable diameters: min. 5 mm; dimensions 4 × 18 mm; delivery unit: 50 pcs. per package

