

QS18EN6DBQ8

Photoelectric Sensor – Diffuse Mode Sensor

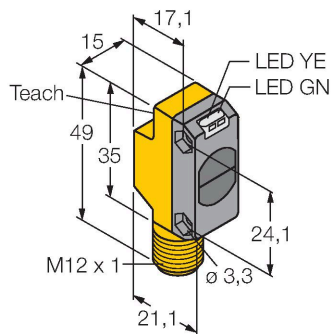

Technical data

Type	QS18EN6DBQ8
ID no.	3071990
Optical data	
Function	Proximity switch
Operating mode	Diffuse
Light type	IR
Wavelength	940 nm
Range	0...500 mm
Electrical data	
Operating voltage	10...30 VDC
DC rated operational current	≤ 100 mA
No-load current	≤ 35 mA
Reverse polarity protection	yes
Output function	NO contact, NPN
Switching frequency	≤ 833 Hz
Readiness delay	≤ 100 ms
Response time typical	< 0.6 ms
Setting option	Push Button Remote Teach
Mechanical data	
Design	Rectangular, QS18
Dimensions	21.1 x 15 x 35 mm
Housing material	Plastic, ABS
Lens	plastic, PMMA
Electrical connection	Connectors, M12 × 1, PVC
Number of cores	4
Ambient temperature	-20...+70 °C

Features

- Male M12 × 1; 4-pin
- Protection class IP67
- LED all-round visible
- Sensitivity adjusted via teach button
- Operating voltage: 10...30 VDC
- NPN switching output
- Light or dark operation

Wiring diagram

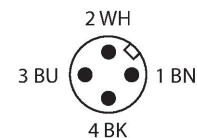
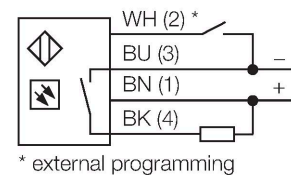

Functional principle

Identical to retro-reflective sensors, emitter and receiver circuitry are incorporated in the same housing of the diffuse mode sensors. However, diffuse mode sensors do not detect the interruption of the light beam but the reflection of the target. A target is detected if it reflects sufficient light back to the receiver. The switching distance of diffuse mode sensors thus largely depends on the reflectivity of the target. This type of sensor is especially suited for detection of transparent objects (diffuse mode sensor with or without background suppression or convergent mode sensors).

Excess gain curve

Technical data

Protection class	IP67
Special features	keep/defer
Power-on indication	LED, Green
Switching state	LED, Yellow
Error indication	LED, green, Flashing
Excess gain indication	LED
Alarm display	LED yellow Flashing
Tests/approvals	
Approvals	CE, cURus

Excess gain in relation to the distance

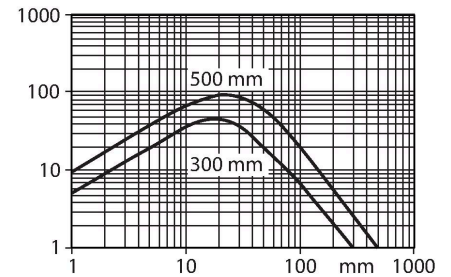

Accessories

SMB18A

3033200

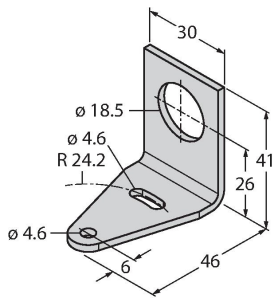

Mounting bracket, rectangular, stainless steel, for sensors with 18 mm thread

SMBQS18A

3069721

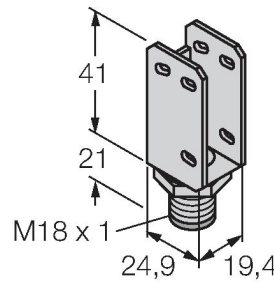

Mounting bracket, stainless steel, for 18 mm thread

SMBQS18AF

3067467

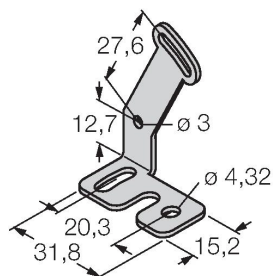

Mounting bracket, stainless steel, for 18 mm thread

Accessories

Dimension drawing	Type	ID no.	
	RKC4.4T-2/TEL	6625013	Connection cable, female M12, straight, 4-pin, cable length: 2 m, sheath material: PVC, black; cULus approval; other cable lengths and qualities available, see www.turck.com
	WKC4.4T-2/TEL	6625025	Connection cable, female M12, angled, 4-pin, cable length: 2 m, sheath material: PVC, black; cULus approval; other cable lengths and qualities available, see www.turck.com