

SLPR14-1530P8

Personnel Safety, Light Screen – Receiver

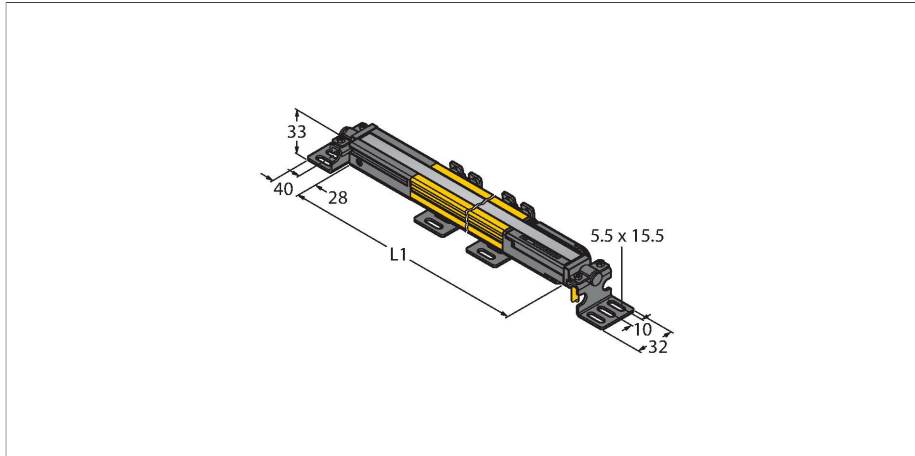

Technical data

Type	SLPR14-1530P8
ID no.	3083561
Optical data	
Function	Light screen
Optical resolution	14 mm
Range	100...7000 mm
Scan field	1530 mm
Number of beams	153
With muting function	no
Scan Code	Adjustable
Electrical data	
Operating voltage	20...28 VDC
Residual ripple	< 10 % U_{ss}
DC rated operational current	≤ 150 mA
Current consumption non-actuated	≤ 150 mA
No-load current	≤ 275 mA
Max. current safe output	0.5 mA
Short-circuit protection	yes
Reverse polarity protection	yes
Output function	2 x NC (normally closed), 2 x PNP
Current output	0...500 mA
Number of safe semiconductor outputs	2
Response time typical	< 37.5 ms
With restart interlock	yes
Blanking function	yes
Mechanical data	
Design	Rectangular, EZ-Screen LP

Features

- Cable with male end M12 × 1, 8-pin, 300 mm
- Protection class IP65
- Flat housing without blind zone
- Adjustment via DIP switch
- Resolution can be reduced
- Blanking function
- Operating voltage: 24 VDC ± 15 %
- Resolution 14 mm
- Scan field 1530 mm (L1)
- Personnel safety Cat 4, PL e acc. to EN ISO 13849-1:2008
- Type 4 according to IEC 61496-1,-2
- SIL 3 to IEC 61508

Wiring diagram

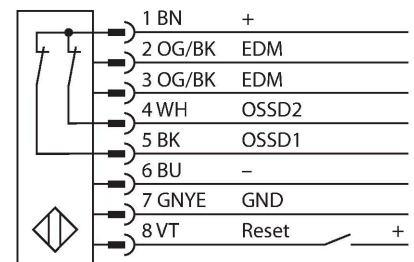

Functional principle

The high-resolution safety light curtain is emitter and receiver in one without blind zone. As the system is synchronized optically, wiring between emitter and receiver is redundant. The safety switching outputs of the receiver are directly connected to a load relay (e.g. IM-TA9A) and trigger an immediate stop of the dangerous machine cycle. The switching device with 2-channel monitoring, diverse redundant designed and mutual processor

Technical data





control, complies with the personnel safety category PLe acc. to ISO 13849-1.

Dimensions	26 x 28 x 1528 mm
Housing material	Metal, AL, Yellow polyester
Lens	plastic, Acrylic
Cascadable	no
Electrical connection	Cable with connector, M12 × 1, 0.3 m
Number of cores	8
Ambient temperature	0...+55 °C
Protection class	IP65
Power-on indication	LED, Green
Switching state	2-color LED, Red
Tests/approvals	
Vibration resistance	10-55 Hz at 0.35 mm
Shock test	10 g at 16 ms (6000 cycles)
Approvals	CE, cTUVus, PL e acc. to ENISO 13849-1:2008, SIL 3 acc. to IEC 61508

Accessories

LPA-MBK-11	3082841	LPA-MBK-12	3082842
	Mounting bracket, retainer for closure caps, 14-ga. steel, galvanized, black, 360 ° sensor rotation, incl.2 pcs. with screw set		Mounting bracket, side mounting, 14-ga. steel, galvanized, black, +10°/-30° sensor rotation, incl.1 pcs. with screw set
LPA-MBK-20	3082853	LPA-MBK-22	3082844
	Mounting bracket, wall mounting, 12-ga. steel, galvanized, black, in combination with LPA-MBK-11/ -12/ -13, incl. 1 pcs. and screw set		Mounting bracket, wall mounting, 14-ga. steel, galvanized, black, in combination with LPA-MBK-11, incl. 2 pcs. and screw set

Accessories

Dimension drawing	Type	ID no.	
	DEE2R-81D	3072205	Connection cable, PVC, yellow, length: 0.31 m, female M12 x 1 - male M12, 8-pin
	DEE2R-83D	3072206	Connection cable, PVC, yellow, length: 0.91 m, female M12 x 1 - male M12, 8-pin
	DEE2R-88D_	3072635	Connection cable, PVC, yellow, length: 2.44 m, female M12 x 1 - male M12, 8-pin
	DEE2R-815D	3072207	Connection cable, PVC, yellow, length: 4.57 m, female M12 x 1 - male M12, 8-pin
	DEE2R-825D	3072208	Connection cable, PVC, yellow, length: 7.62 m, female M12 x 1 - male M12, 8-pin
	DEE2R-850D	3072209	Connection cable, PVC, yellow, length: 15.2 m, female M12 x 1 - male M12, 8-pin
	DEE2R-875D	3072210	Connection cable, PVC, yellow, length: 22.9 m, female M12 x 1 - male M12, 8-pin
	DEE2R-8100D	3072211	Connection cable, PVC, yellow, length: 30.5 m, female M12 x 1 - male M12, 8-pin
	QDE-815D	3070883	Connection cable for safety light screens, PVC, yellow, length 4.57 m, female connection, M12 x 1, 8-pin
	QDE-825D	3070884	Connection cable for safety light screens, PVC, yellow, length 7.62 m, female connection, M12 x 1, 8-pin
	QDE-850D	3070885	Connection cable for safety light screens, PVC, yellow, length 15.3 m, female connection, M12 x 1, 8-pin
	QDE-875D	3071466	Connection cable for safety light screens, PVC, yellow, length 22.9 m, female connection, M12 x 1, 8-pin
	QDE-8100D	3071467	Connection cable for safety light screens, PVC, yellow, length 30.5 m, female connection, M12 x 1, 8-pin
	CSB-M1280M1280	3075375	Y-piece, PVC, yellow, with male M12 x 1, 8-pin on 2 x 0.3 m cable, PVC, yellow, with female M12 x 1, 8-pin
	CSB-M1281M1281	3073252	Y-piece, PVC, yellow, length: 0.3 m with male, M12 x 1, 8-pin on 2 x 0.3 m cable, PVC, yellow, with female, M12 x 1, 8-pin
	CSB-M1288M1281	3073253	Y-piece, PVC, yellow, length: 2.5 m with male, M12 x 1, 8-pin on 2 x 0.3 m cable, PVC, yellow, with female, M12 x 1, 8-pin
	CSB-M12815M1281	3073254	Y-piece, PVC, yellow, length: 4.6 m with male, M12 x 1, 8-pin on 2 x 0.3 m cable,

Dimension drawing	Type	ID no.	
			PVC, yellow, with female, M12 x 1, 8-pin
	CSB-M12825M1281	3073255	Y-piece, PVC, yellow, length: 7.6 m with male, M12 x 1, 8-pin on 2 x 0.3 m cable, PVC, yellow, with female, M12 x 1, 8-pin
	DEE2R-88D	3094306	Connection cable, PVC, yellow, length: 2.44 m, M12 x 1 female connector, 8-pin, on M12 x 1 male connector, 8-pin