

# RSC5T-2/TXL1001

## Weld-Splatter Resistant Actuator and Sensor Cable – Connection Cable

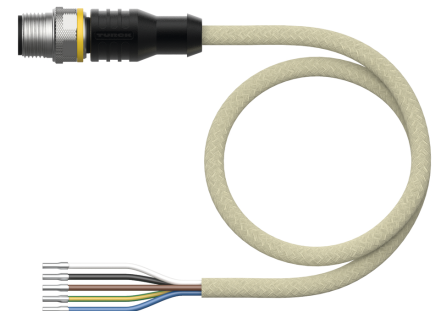
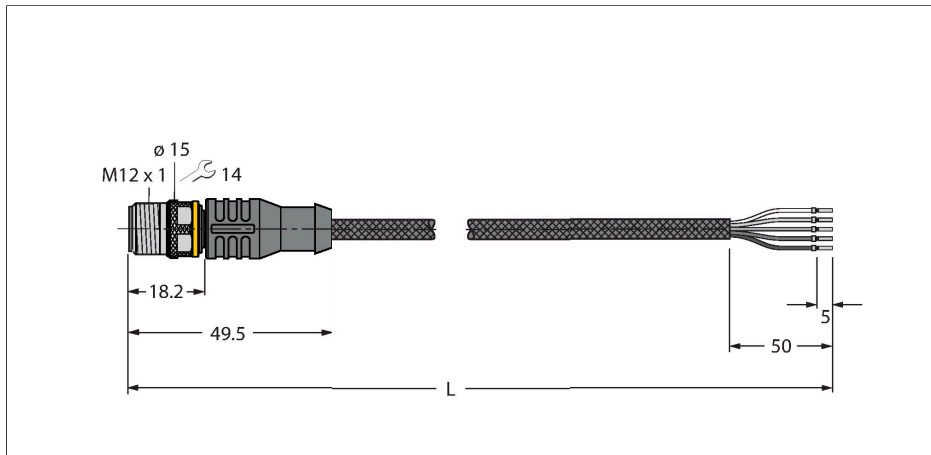

### Technical data

Type	RSC5T-2/TXL1001
ID	6630277
Remark to product	!!! Pin 5 = PE !!!
Connector A	Male, M12 × 1, Straight, A-coded
Number of Pins	4+PE
Contacts	Brass, CuZn, Gold-plated
Contact carriers	Plastic, TPU, Black
Connector body	Plastic, TPU, Black
Coupling nut/screw	Brass, CuZn, Nickel-plated
Mechanical lifespan	> 100 Mating cycles
Pollution degree	3
Protection class	IP67, IP69K, Only in screwed condition
Cable	
Cable diameter	Ø 6.1 mm ±0.20
Cable length	2 m
Cable jacket	PUR, Yellow
Core insulation	PP
Core cross-section	5 x 0.34 mm <sup>2</sup>
Arrangement of strands	42 x 0.1 mm
Core colors	BN, WH, BU, BK, GNYE
Electrical properties at +20 °C	
Rated voltage	60 V
Test voltage	2000 V
Current	4 A
Insulation resistance	> 30.5 MΩ/km
forward resistance	max. 57 Ω/km

### Features



- Male M12, straight, 4-pin + PE
- Jacket material: PUR jacketed with aramid fibers
- Jacket color: yellow
- Resistant to welding sparks
- Flame retardant
- Resistant to chemicals, UV radiation and oils
- Free from halogen, silicone, PVC and LABS
- Protection class: IP67, IP69K
- Protective jacket material: aramid fibers
  - Tensile strength: 2923 MPa
  - Breaking strength: 333 N
  - Elongation at break: 3.6 %
  - Temperature peaks: up to +200 °C
- Cable length: 2.0 m

### Cable Cross-Section

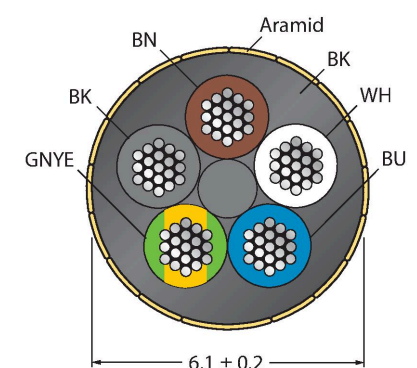

## Technical data

## Contact assignment

### Mechanical and chemical properties

Bending radius (stationary installation)	$\geq 5 \times \varnothing$
Bending radius (flexible use)	$\geq 10 \times \varnothing$
Ambient temperature range (stationary)	-50...+105 °C
Ambient temperature range (In motion)	-30...+90 °C

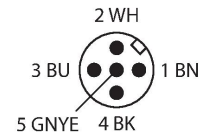

## Circuit Diagram

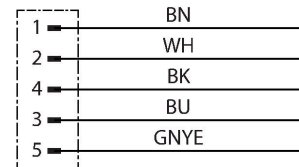

## Accessories

### TORQUE-WRENCH-SET-AS

6936170

Torque wrench set; handles with adjustable torque 0.4-1.0 Nm, torque wrench for M8 (SW9), fork wrench for M12 (SW 14)

### B8151-0

6904601

Field-wireable female connector, M12 × 1, straight, 5-pin, screw terminal connection, cable feedthrough 4.0 to 6.0 mm, core cross-section/terminal capacity 0.14 to 0.75 mm<sup>2</sup>, plastic housing, plastic nut

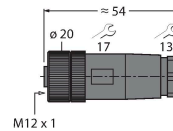

### B8251-0

6904602

Field-wireable female connector, M12 × 1, angled, 5-pin, screw terminal connection, cable feedthrough 4.0 to 6.0 mm, core cross-section/terminal capacity 0.14 to 0.75 mm<sup>2</sup>, plastic housing, plastic nut

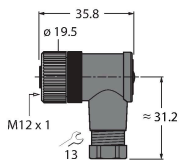

### BM8151-0

6935888

Field-wireable female connector, M12 × 1, straight, 5-pin, screw terminal connection, cable feedthrough 4.0 to 6.0 mm, core cross-section/terminal capacity 0.25 to 0.75 mm<sup>2</sup>, plastic housing, metal nut

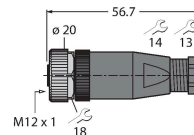

### BM8251-0

6935890

Field-wireable female connector, M12 × 1, angled, 5-pin, screw terminal connection, cable feedthrough 4.0 to 6.0 mm, core cross-section/terminal capacity 0.25 to 0.75 mm<sup>2</sup>, plastic housing, metal nut

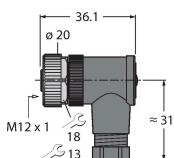

### FW-ERKPM0526-SA-P-0408

100002534

Field-wireable female connector, M12 × 1, straight, 5-pin, push-in connection, cable feedthrough 4.0 to 8.0 mm, core cross-section/terminal capacity 0.14 to 0.75 mm<sup>2</sup>, plastic housing, metal coupling nut

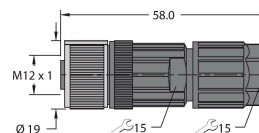

FW-ERKPM0516-SA-S-0408

10002285

Field-wireable female connector, M12 × 1, straight, 5-pin, screw terminal connection, cable feedthrough 4.0 to 8.0 mm, core cross-section/terminal capacity 0.25 to 1.5 mm<sup>2</sup>, plastic housing, metal nut

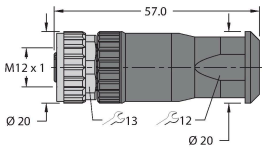

FW-EWKPM0516-SA-S-0408

10002287

Field-wireable female connector, M12 × 1, angled, 5-pin, screw terminal connection, cable feedthrough 4.0 to 8.0 mm, core cross-section/terminal capacity 0.25 to 1.5 mm<sup>2</sup>, plastic housing, metal nut

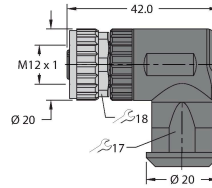

## Accessories

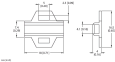
Dimension drawing	Type	ID	
	LABEL-HOLDER-FLEX-PVC	100048170	PVC label holder for identification of extension cables (TEL/TXL product series); for cable diameters: min. 5 mm; dimensions 4 × 18 mm; delivery unit: 50 pcs. per package