

RKC4.5T-0.3-RSC4.5T/TXO3701

Welding Spark Resistant Actuator and Sensor Cable – Extension Cable

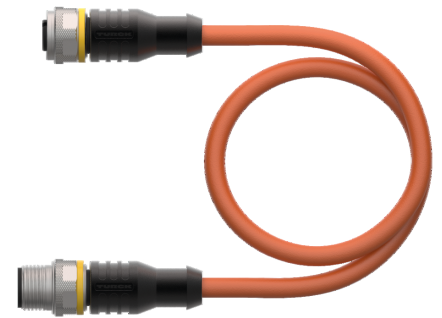
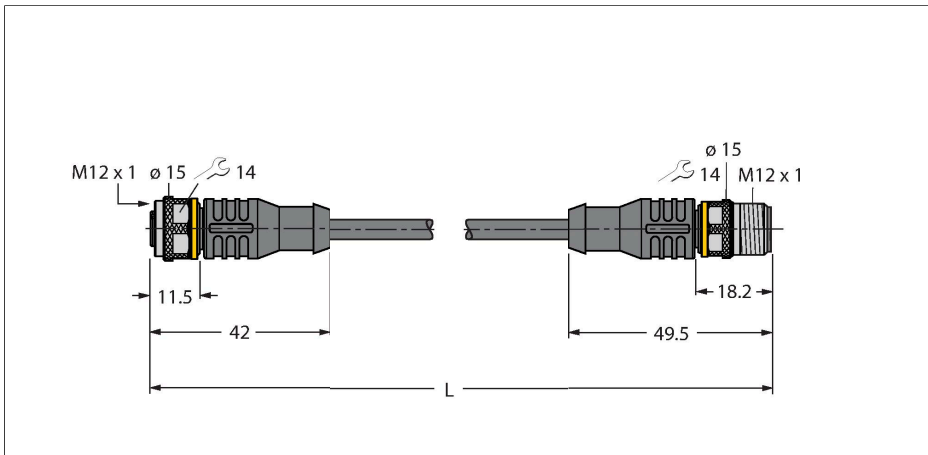

Technical data

Type	RKC4.5T-0.3-RSC4.5T/TXO3701
ID	6635699
Remark to product	Specification according to VASS requirements (version: February 2021)
Connector A	Female, M12 × 1, Straight, A-coded
Number of Pins	5
Contacts	Brass, CuZn, Gold-plated
Contact carriers	Plastic, TPU, Black
Connector body	Plastic, TPU, Black
Coupling nut/screw	Brass, CuZn, Nickel-plated
Seal	Plastic, FPM/FKM
Mechanical lifespan	> 100 Mating cycles
Pollution degree	3
Protection class	IP67, IP69K, Only in screwed condition
Connector B	Male, M12 × 1, Straight, A-coded
Number of pins	5
Contacts	Brass, CuZn, Gold-plated
Contact carriers	Plastic, TPU, Black
Connector body	Plastic, TPU, Black
Coupling nut/retaining screw	Brass, CuZn, Nickel-plated
Mechanical life	> 100 Mating cycles
Pollution degree	3
Protection class	IP67, IP69K, Only when screwed together
Cable	
Cable diameter	Ø 6 mm ±0.20
Cable length	0.3 m

Features



- Female M12, straight, 5-pin
- Male M12, straight, 5-pin
- Jacket material: PUR
- Jacket color: orange
- Resistant to welding sparks
- Suitable for drag chain use
- Resistant to chemicals, UV radiation and oils
- Flame retardant (FT2 acc. to UL/CSA; IEC 60332-1-2; IEC 60332-2-2)
- Halogen free (acc. to EN 50267-2-1)
- Free from silicone, PVC and LABS (acc. to PV3.10.7)
- Particularly resistant to abrasion
- Protection class: IP67, IP69K
- Cable length: 0.3 m

Contact assignment



Circuit Diagram



Technical data

Cable jacket	PUR, Orange
Core insulation	PP
Core cross-section	5 x 0.34 mm ²
Core colors	BN, WH, BU, BK, GY
Electrical properties at +20 °C	
Rated voltage	60 V
Test voltage	2000 V
Current	4 A
forward resistance	max. 60 Ω/km
Mechanical and chemical properties	
Bending radius (stationary installation)	≥ 5 x Ø
Bending radius (flexible use)	≥ 10 x Ø
Bending cycles	≥ 5 million
Admissible acceleration	max. 10 m/s ²
Admissible travel path, horizontal	10 m (at 10 m/s ²)
Admissible travel path, vertical	10 m (at 10 m/s ²)
Admissible traversing speed	3.3 m/s
Torsional stress	± 180 °/m
Ambient temperature range (stationary)	-40...+80 °C
Ambient temperature range (In motion)	-25...+80 °C
Ambient temperature during drag chain operation	-25...+60 °C
Approvals	cULus

Accessories

TORQUE-WRENCH-SET-AS	6936170
Torque wrench set; handles with adjustable torque 0.4-1.0 Nm, torque wrench for M8 (SW9), fork wrench for M12 (SW 14)	

Accessories

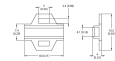
Dimension drawing	Type	ID	
	LABEL-HOLDER-FLEX-PVC	100048170	PVC label holder for identification of extension cables (TEL/TXL product series); for cable diameters: min. 5 mm; dimensions 4 × 18 mm; delivery unit: 50 pcs. per package