

RKP46PSB-20/TXR

Supply Cable — M12 Power – Connection Cable

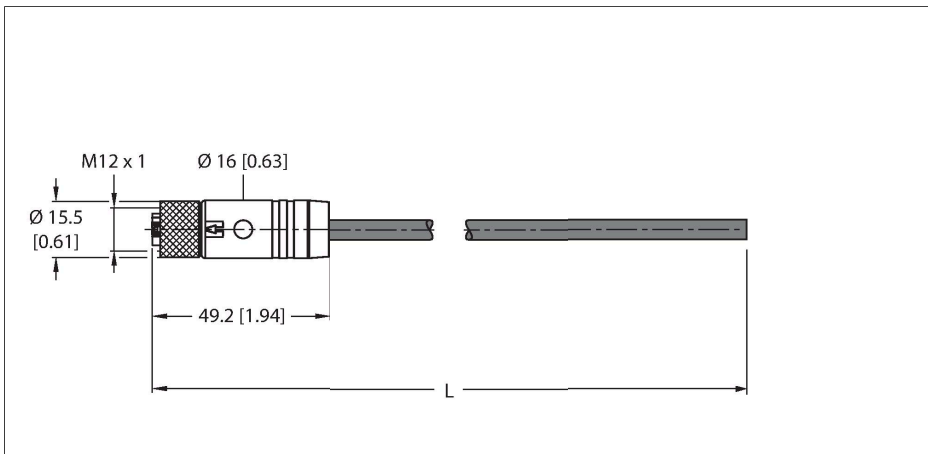

Technical data

Type	RKP46PSB-20/TXR
ID	100030344
Connector A	Female, M12 × 1, Straight, S-coded
Number of Pins	3+PE
Contacts	Copper-nickel, CuNi, Gold-plated
Contact carriers	Plastic, PBT GF, Black
Connector body	Plastic, TPE, Black
Coupling nut/screw	Brass, CuZn, Nickel-plated
Seal	Plastic, FPM/FKM
Tightening torque (range)	0.5 ... 0.6 Nm (observe max. torque of mating connector!)
Mechanical lifespan	> 100 Mating cycles
Pollution degree	3
Protection class	IP65, IP67, IP69K, Only in screwed condition
Cable	
Cable diameter	Ø 7.4 mm ±0.20
Cable length	20 m
Cable jacket	PUR, Red
Core insulation	PP
Core cross-section	4 x 1.5 mm ²
Core colors	BK1, BK2, BK3, GNYE
Electrical properties at +20 °C	
Rated voltage	600 V
Current	16 A
Mechanical and chemical properties	
Bending radius (stationary installation)	≥ 4 x Ø

Features



- M12 female connector, S-coded, straight, 4-pin (3+PE)
- Sheathing material: PUR
- Jacket color: red
- Highly resistant against oils, coolants, lubricants and emulsions
- Suitable for use in drag chains
- Resistant to vibrations and shocks
- Flame-retardant
- Halogen-free
- RoHS-compliant
- Protection class: IP65, IP67, IP69K
- Cable length: 20 m

Contact assignment

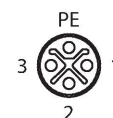

Circuit Diagram



Technical data

Bending radius (flexible use)	$\geq 7 \times \varnothing$
Bending cycles	≥ 10 million
Admissible acceleration	max. 5 m/s ²
Admissible travel path, horizontal	5 m (at 5 m/s ²)
Torsional stress	± 30 °/m
Ambient temperature range (stationary)	-40...+80 °C
Ambient temperature range (In motion)	-30...+80 °C
Ambient temperature during drag chain operation	-20...+60 °C
Qualified for drag chain use	yes
Halogen-free	yes
Oil-resistant	yes
Flame-retardant	yes

Derating Curve

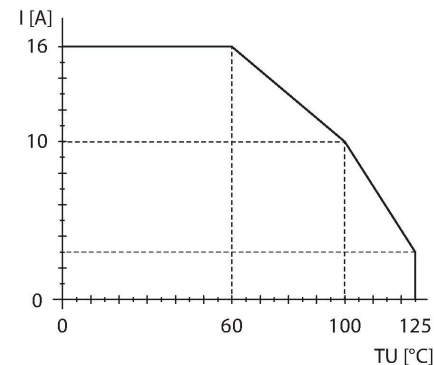

Accessories

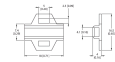
Dimension drawing	Type	ID	
	LABEL-HOLDER-FLEX-PVC	100048170	PVC label holder for identification of extension cables (TEL/TXL product series); for cable diameters: min. 5 mm; dimensions 4 × 18 mm; delivery unit: 50 pcs. per package