

RKCV4.5T-2-RSCV4.5T/TFW

Actuator And Sensor Cable, PP-EPDM – Extension Cable

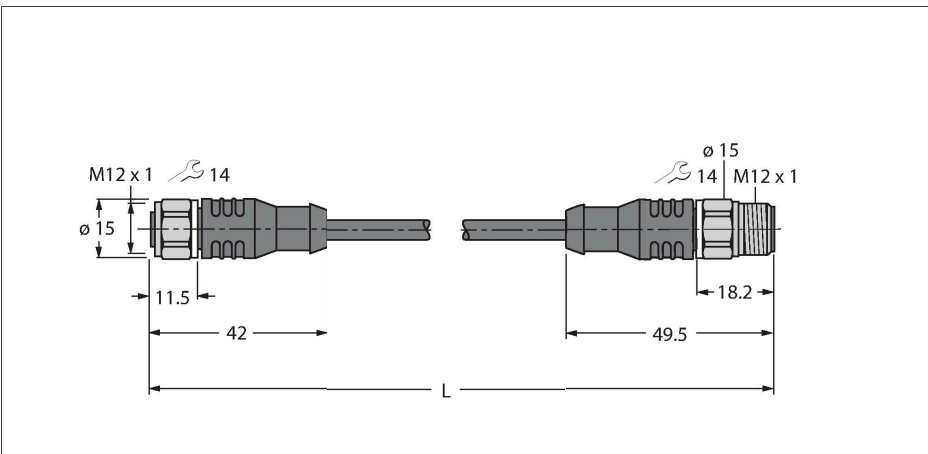

Features



- M12 female connector, straight, 5-pin
- Stainless steel coupling nut/screw
- M12 male connector, straight, 5-pin
- Sheath material: PP-EPDM
- Sheath color: white
- Resistant to acids and alkaline solutions
- Resistant to detergents and disinfectants
- Resistant to hydrolysis acc. to DIN EN 60068-2-78
- Free from silicone and PVC
- Halogen-free acc. to DIN EN 50267-2-1, IEC 60754-1, VDE 0482-267-2-1
- Approvals: Ecolab, FDA
- RoHS and REACH compliant
- Protection classes IP67, IP69K
- Cable length: 2.0 m

Technical data

Type	RKCV4.5T-2-RSCV4.5T/TFW
ID	6935427
Connector A	Female, M12 × 1, Straight
Number of Pins	5
Contacts	Brass, CuZn, Gold-plated
Contact carriers	Plastic, PP, White
Connector body	Plastic, PP, White
Coupling nut/screw	Stainless Steel, V4A
Seal	Plastic, FPM/FKM
Tightening torque (range)	0.8 ... 1 Nm (observe max. torque of mating connector!)
Mechanical lifespan	> 100 Mating cycles
Pollution degree	3
Protection class	IP67, IP69K, Only in screwed condition
Connector B	Male, M12 × 1, Straight
Number of pins	5
Contacts	Brass, CuZn, Gold-plated
Contact carriers	Plastic, PP, White
Connector body	Plastic, TPU, White
Coupling nut/retaining screw	Stainless Steel, V4A
Tightening torque	0.8 ... 1 Nm (observe max. torque of mating connector!)
Mechanical life	> 100 Mating cycles
Pollution degree	3
Protection class	IP67, IP69K, Only when screwed together
Cable	
Cable diameter	Ø 4.5 mm ±0.20

Cable Cross-Section

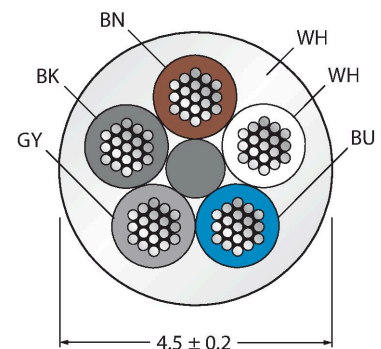

Contact assignment



Technical data

Cable length	2 m
Cable jacket	PP-EPDM, White
Core insulation	PE
Core cross-section	5 x 0.34 mm ²
Arrangement of strands	42 x 0.1 mm
Core colors	BN, WH, BU, BK, GY
Electrical properties at +20 °C	
Rated voltage	60 V
Test voltage	500 V
Current	4 A
forward resistance	max. 57 Ω/km
Mechanical and chemical properties	
Bending radius (stationary installation)	≥ 5 x Ø
Bending radius (flexible use)	≥ 10 x Ø
Ambient temperature range (stationary)	-40...+105 °C
Ambient temperature range (In motion)	0...+80 °C

Circuit Diagram



Accessories

TORQUE-WRENCH-SET-AS	6936170
Torque wrench set; handles with adjustable torque 0.4-1.0 Nm, torque wrench for M8 (SW9), fork wrench for M12 (SW 14)	