

TNSLR-Q80WD-H1147/C53

HF Read/Write Head – For Bus Line Topology with TBEN-*

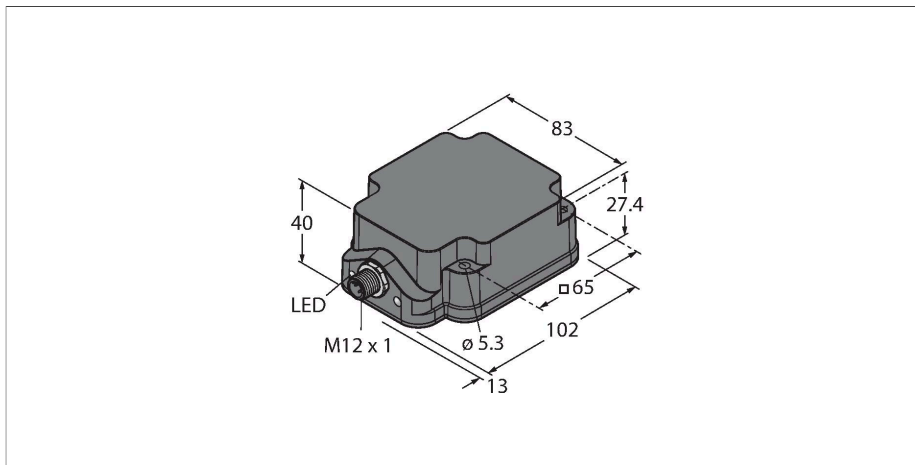

Technical data

Type	TNSLR-Q80WD-H1147/C53
ID	100001312
Remark to product	Wash-Down (IP69K), very long range
Approvals	CE UKCA UL
Radio approvals	EU/RED: Europe UK SI 2017/1206: United Kingdom FCC: USA MIC: Japan RCM: Australia/New Zealand
Electrical data	
Operating voltage	19.2...28.8 VDC
DC rated operational current	≤ 90 mA
inrush current	1200 mA For: 1 ms
Data transfer	Inductive coupling
Technology	HF RFID
Operating frequency	13.56 MHz
Radio communication and protocol standards	ISO 15693 NFC Typ 5
Read/Write distance max.	280 mm
Output function	4-wire, Read/Write
Suitable for bus mode to TBEN-*	Yes
Mechanical data	
Mounting conditions	Non-flush, partially embeddable
Ambient temperature	-25...+70 °C
Design	Rectangular, Q80WD
Dimensions	102 x 83 x 40 mm
Housing material	Plastic, Black
Active area material	Plastic, PPS-GF30, black

Features

- Rectangular, height 40 mm
- Active face on top
- Plastic, PPS-GF30
- Device without end termination
- Device may only be operated in line topology TBEN-S*-2RFID-* or TBEN-L*-4RFID-*
- Max. 32 nodes per line or connection permitted
- Use a corresponding terminating resistor (see accessories)
- Observe the performance of the power supply, especially when turned on, and the maximum current carrying capacity of the cables
- Observe the voltage drop on the line
- The maximum possible length of the spur line is 2 m
- The maximum possible length of the bus is 50 m
- By default, a command can only be processed by one read/write head, making HF bus mode suitable for static applications and slow dynamic applications
- In continuous HF bus mode, a command is executed simultaneously on all read/write heads in a bus topology. The recorded data is stored in the ring buffer of the module
- The read/write head is automatically assigned an address
- For different application requirements, the address and can be parameterized
- Powered and operated only via connection to BL ident interface module
- M12 × 1 connector, connection only via BL ident extension cable

.../S2503 Connectors

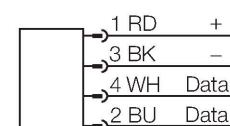

Technical data

Vibration resistance	55 Hz (1 mm)
Shock resistance	30 g (11 ms)
Protection class	IP68 IP69K
Electrical connection	M12 × 1
Power-on indication	LED, Green
Packaging unit	1

.../S2500 Connectors

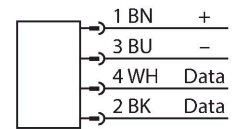

.../S2501 Connectors

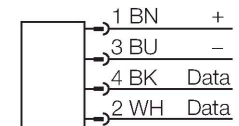

Functional principle

The HF read/write devices operating at a frequency of 13.56 MHz form a transmission zone, the size of which (0...500 mm) varies depending on the combination of read/write device and tag used.

The read/write distances mentioned here only represent standard values measured under laboratory conditions, free from any influences caused by surrounding materials.

The read/write distances of the tags for mounting in metal TW-R**-M(MF) were determined in metal.

Attainable distances may vary by up to 30 % due to component tolerances, mounting conditions, ambient conditions and material qualities (especially when mounted in metal). Testing of the application under real operating conditions is therefore essential, especially with on-the-fly reading and writing!

This figure illustrates an example of operating a read/write head in a compact multiprotocol I/O module TBEN-S*-2RFID-* or TBEN-L*-4RFID-* in a line topology

Mounting instructions/Description

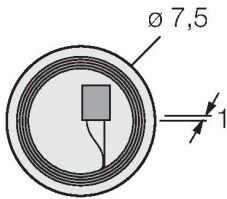
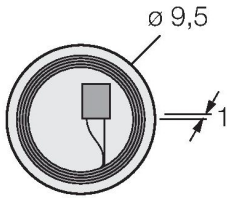
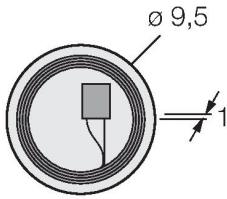
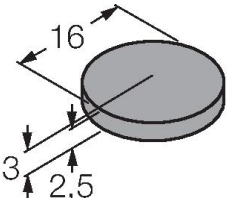
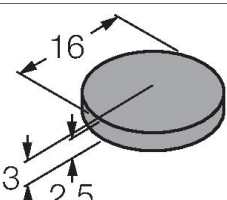
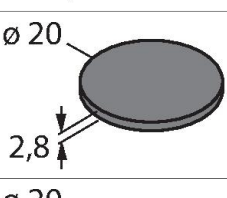
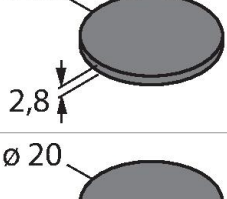
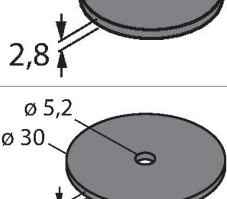
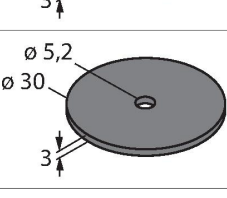
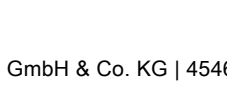

Dimensions	Type designation	Read-write distance		Transfer zone		Minimum distance between two read-write heads [mm]
		Recommended (mm)	max. [mm]	length max. [mm]	width offset max. [mm]	
	Ident - no.					

	TW-R7.5-B128 7030231	48	95	104	52	450
	TW-R9.5-B128 7030252	50	100	106	53	450
	TW-R9.5-K2 7030558	48	97	106	53	450
	TW-R16-B128 6900501	75	146	144	72	450
	TW-R16-K2 7030410	48	97	106	53	450
	TW-R20-B128 6900502	74	140	140	70	450
	TW-R20-B320 100005244	74	140	140	70	450
	TW-R20-K2 6900505	68	130	132	66	450
	TW-R30-B128 6900503	110	186	176	88	450
	TW-R30-B320 100005245	110	186	176	88	450

	TW-R30-K2 6900506	74	138	136	68	450
	TW-R50-B128 6900504	134	240	228	114	450
	TW-R50-B320 100005246	134	240	228	114	450
	TW-R50-K2 6900507	120	218	208	104	450
	TW-R10-M-B146 7030545	25	52	80	40	450
	TW-R12-M-B146 7030500	28	55	86	43	450
	TW-L18-18-F-B128 7030634	73	136	132	76	450
	TW-Q51WH-HT-B128 7030661	145	260	250	125	450
	TW-B58X1.25-19-K9/C55 100000368	23	56	72	36	450

Accessories

Dimension drawing	Type	ID	
	RSE57-TR2/RFID	6934908	Terminating resistor to build an RFID line topology

Dimension drawing

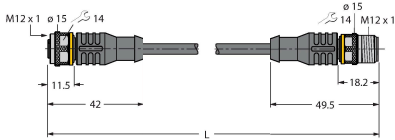
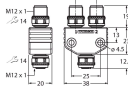
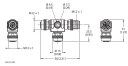

Type	ID	
VT2-FKM5-FKM5-FSM5	6930573	T-splitter to build an RFID line topology
VB2-FKM5-FSM5.205-FSM5.305/S2550	6936821	Y-splitter for re-powering a supply voltage for the RFID bus topology
RK4.5T-2-RS4.5T/S2503	7030331	BL ident cable, M12 female connector, straight to M12 male connector, cable length: 2 m, jacket material: PUR, black; other cable lengths and qualities available, see www.turck.com