

# RSSD-RJ45S-4416-0.5M

## Industrial Ethernet/PROFINET Cable – Extension Cable

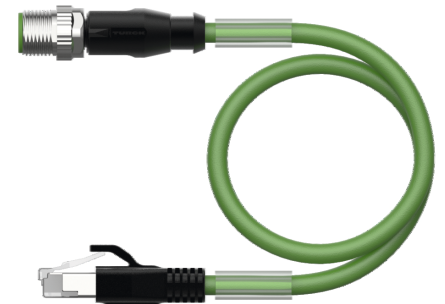
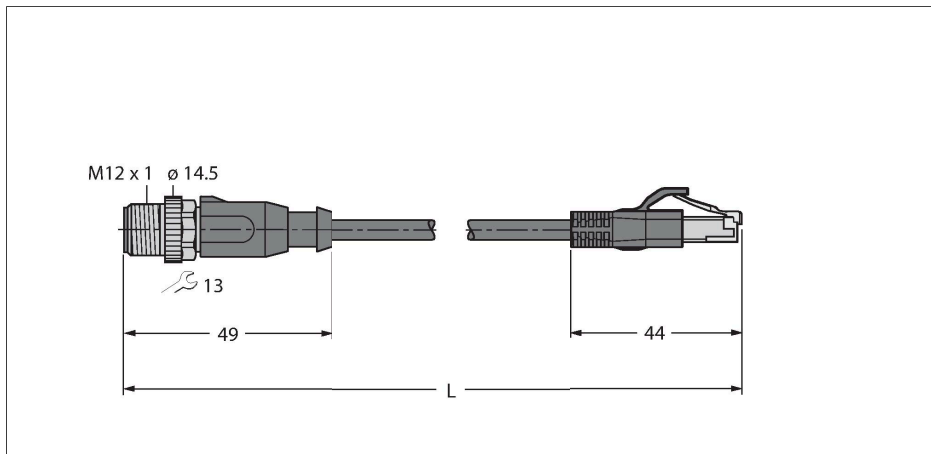

### Technical data

Type	RSSD-RJ45S-4416-0.5M
ID	6441628
Connector A	Male, M12 × 1, Straight, D-coded
Number of Pins	4
Contacts	Metal, CuZn, Gold-plated
Contact carriers	Plastic, PA, UL 94, Black
Connector body	Plastic, TPU, UL 94, Black
Coupling nut/screw	Brass, GD-Zn, Nickel-plated
Tightening torque (range)	0.4 ... 0.6 Nm (observe max. torque of mating connector!)
Mechanical lifespan	> 100 Mating cycles
Pollution degree	3/2
Protection class	IP67, Only in screwed condition
Connector B	Male, RJ45, Straight
Number of pins	4
Contacts	Metal, CuZn, Gold-plated
Contact carriers	Plastic, PC
Connector body	Plastic, TPU, UL 94
Mechanical life	> 100 Mating cycles
Pollution degree	3/2
Protection class	IP20
Cable	
Network protocol	Ethernet
Cable diameter	Ø 6.5 mm ±0.20
Cable length	0.5 m
Cable jacket	PUR, Green
Shielding	Aluminum foil, tinned copper wire

### Features



- M12 male connector, straight, D-coded
- RJ45 male connector, straight, 4-pin
- Ethernet cable: 4-pin, AWG 22
- CAT 5E
- Jacket material: PUR
- Jacket color: green
- Shielding: overlapping aluminum foil, tinned copper wire
- Jacket diameter: 6.5 mm
- Suitable for drag chain use
- Oil resistant acc. to IEC 60811-2-1 and UL13
- Halogen free acc. to IEC 60754
- Flame retardant acc. to IEC 60332-1-2 and UL2556 VW1
- Approval: UL
- RoHS compliant
- PNO compliant
- Cable length: 0.5 m

### Cable Cross-Section

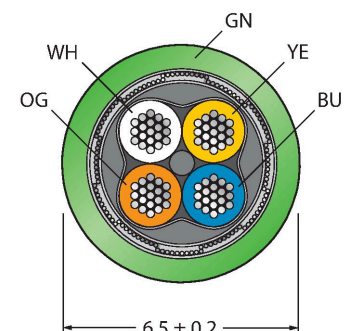

## Technical data

Core insulation	PE
Core cross-section	4 x 0.32 mm <sup>2</sup>
Arrangement of strands	7 x 0.25 mm
Core colors	WH, YE, BU, OG
<b>Electrical properties at +20 °C</b>	
Test voltage	2000 V
Current	3 A
DC resistance (loop)	120 Ω/km
Nom. impedance	100 Ω (1MHZ)
Nom. capacitance	50 pF/m
<b>Mechanical and chemical properties</b>	
Bending radius (stationary installation)	≥ 5 x Ø
Bending radius (flexible use)	≥ 8 x Ø
Bending cycles	≥ 3 million
Torsional stress	± 180 °/m
Torsion cycles	≤ 100,000 Cycles
Ambient temperature range (stationary)	-50...+70 °C
Ambient temperature range (In motion)	-20...+60 °C
<b>Other Features</b>	
Qualified for drag chain use	yes
Halogen-free	yes
PVC-free	yes
UV resistance	yes
Oil-resistant	yes
Flame-retardant	yes
Approvals	UL Listed

## Contact assignment

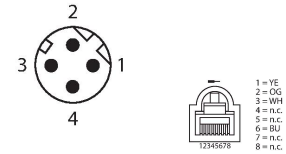

## Circuit Diagram

