

RJ45S-RJ45S-8814-4M

Industrial Ethernet Cable – Connection Cable

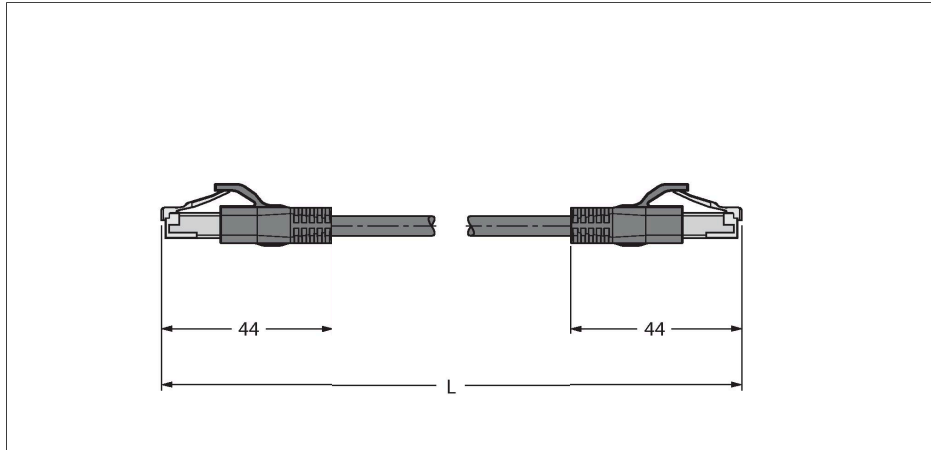

Features



- RJ45 male connector, straight, 8-pin
- RJ45 male connector, straight, 8-pin
- Ethernet cable: 8-pin, AWG 26, CAT 6A
- Jacket material: PUR
- Jacket color: green
- Jacket diameter: 6.7 mm
- Paired and shielded
- Oil resistant acc. to DIN EN 60811-404 (7 × 24 h/90 °C)
- UV resistant
- Flame retardant acc. to IEC 60332-2
- Approval: cULus
- RoHS compliant (2011/65/EC)
- Cable length: 4.0 m

Technical data

Type	RJ45S-RJ45S-8814-4M
ID	100000697
Connector A	Male, RJ45, Straight
Number of Pins	8
Contacts	Metal, CuZn, Gold-plated
Contact carriers	Plastic, PC
Connector body	Plastic, TPU, Black
Mechanical lifespan	> 100 Mating cycles
Pollution degree	3/2
Protection class	IP20
Connector B	Male, RJ45, Straight
Number of pins	8
Contacts	Metal, CuZn, Gold-plated
Contact carriers	Plastic, PC
Connector body	Plastic, TPU, UL 94
Mechanical life	> 100 Mating cycles
Pollution degree	3/2
Protection class	IP20
Cable	
Network protocol	Ethernet
Cable diameter	Ø 6.7 mm ±0.30
Cable length	4 m
Cable jacket	PUR, Green
Shielding	yes
Core insulation	PE
Core cross-section	8 x 0.14 mm ²
Arrangement of strands	0.16 mm

Cable Cross-Section

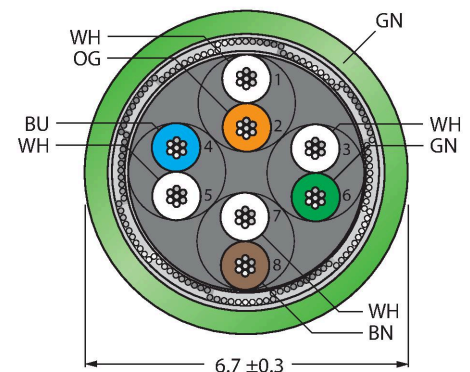

Circuit Diagram

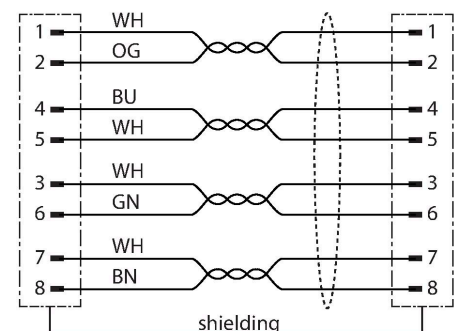

Technical data

Core colors WH(OG)|OG;WH(GN)|GN;WH(BN)|BN;WH(BU)|BU

Electrical properties at +20 °C	
Rated voltage	48 V
Test voltage	700 V
Current	0.5 A
Mechanical and chemical properties	
Bending radius (stationary installation)	≥ 5 x Ø
Bending radius (flexible use)	≥ 10 x Ø
Ambient temperature range (stationary)	-40...+80 °C
Ambient temperature range (In motion)	-40...+80 °C
Other Features	
Qualified for drag chain use	yes
PVC-free	yes
UV resistance	yes
Oil-resistant	yes
Flame-retardant	yes
Approvals	cULus

Accessories

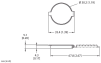
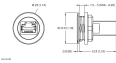
Dimension drawing	Type	ID	
	VK-RJ45SF-88 (10PCS)	100048233	Verschlusskappe IP67 für RJ45 Adapter, Wanddurchführung
	RJ45SF-RJ45SF-88	100048230	Adapter, Wanddurchführung, RJ45-Kupplung auf RJ45 Kupplung, gerade, 8-polig