

Q12AB6LPQ

Photoelectric Sensor – Retroreflective Sensor with Polarizing Filter

Miniature Sensor

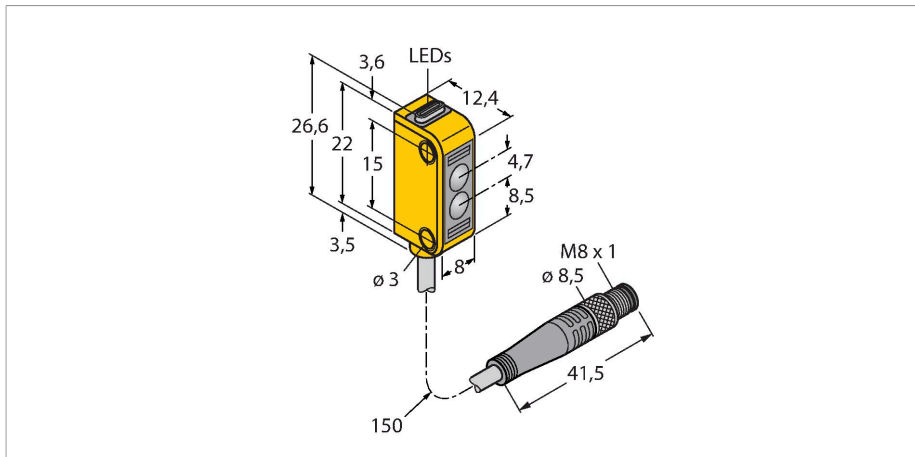

Technical data

Type	Q12AB6LPQ
ID no.	3072129
Optical data	
Function	Retroreflective Sensor
Operating mode	Polarized
Reflector included in delivery	no
Light type	Red polarized
Wavelength	640 nm
Range	100...1000 mm
Electrical data	
Operating voltage	10...30 VDC
Residual ripple	< 10 % U _{ss}
DC rated operational current	≤ 50 mA
No-load current	≤ 20 mA
Short-circuit protection	yes
Reverse polarity protection	yes
Output function	NO contact, light operation, PNP/NPN
Switching frequency	≤ 700 Hz
Readiness delay	≤ 120 ms
Response time typical	< 0.7 ms
Mechanical data	
Design	Rectangular, Q12
Dimensions	12.4 x 8 x 26.6 mm
Housing material	Plastic, Thermoplastic material, Yellow

Features

- Cable, PVC, 150 mm, with M8 × 1 male end, 4-pin
- Protection class IP67
- LED all-round visible
- Indication of insufficient excess gain
- Glass lens
- Operating voltage: 10...30 VDC
- Switching output, bipolar, light operation

Wiring diagram

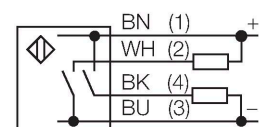

Functional principle

Retro-reflective sensors incorporate emitter and receiver in a single compact housing. The light beam of the emitter is directed towards a reflector which returns the light back to the receiver. An object is detected when it interrupts this beam. Retro-reflective sensors incorporate some of the advantages of opposed mode sensors (good contrast and high excess gain). Further it is merely required to install and wire a single device.

Technical data

Lens	glass, Glass
Electrical connection	Cable with connector, M8 × 1, 0.15 m, PVC
Number of cores	4
Core cross-section	0.34 mm ²
Ambient temperature	-20...+55 °C
Protection class	IP67
Power-on indication	LED, Green
Switching state	LED, Yellow
Error indication	LED, green
Excess gain indication	LED, yellow, flashing
Tests/approvals	
MTTF	135 years acc. to SN 29500 (Ed. 99) 40 °C
Approvals	CE, cURus

A smaller sensing range and susceptibility of devices without polarisation filter can be of disadvantage when shiny objects have to be detected.

Excess gain curve
Excess gain in relation to the distance

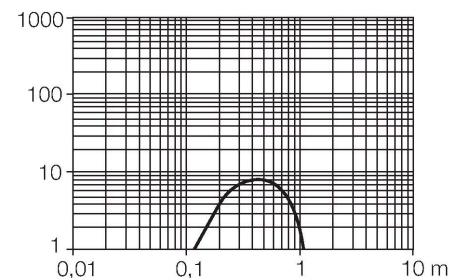

Accessories

SMBQ12A

3074341

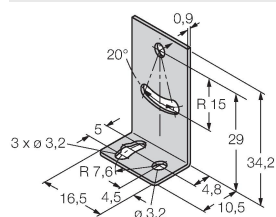

Mounting bracket; material VA 1.4401, for photoelectric sensor, Q12 series

SMBQ12T

3073722

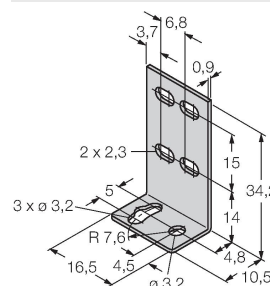

Mounting bracket; material VA 1.4401, for photoelectric sensor, Q12 series

Accessories

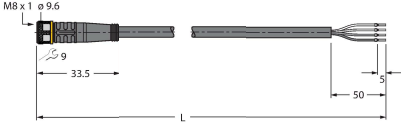
Dimension drawing	Type	ID no.	
	PKW4M-2/TEL	6625067	Connection cable, female M8, angled, 4-pin, cable length: 2 m, sheath material: PVC, black; cULus approval; other cable lengths and qualities available, see www.turck.com
	PKG4M-2/TEL	6625061	Connection cable, female M8, straight, 4-pin, cable length: 2 m, sheath material: PVC, black; cULus approval; other cable lengths and qualities available, see www.turck.com

Accessories

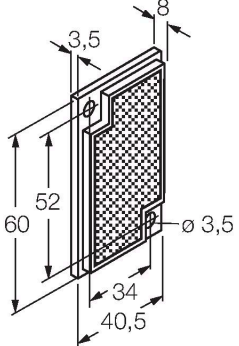
Dimension drawing	Type	ID no.	
	BRT-60X40C	3044997	Rectangular reflector, reflection coefficient 1.48, material: acrylic, ambient temperature -20...+60 °C