

RKP56PLA-15/TXG

Supply Cable — M12 Power – Connection Cable

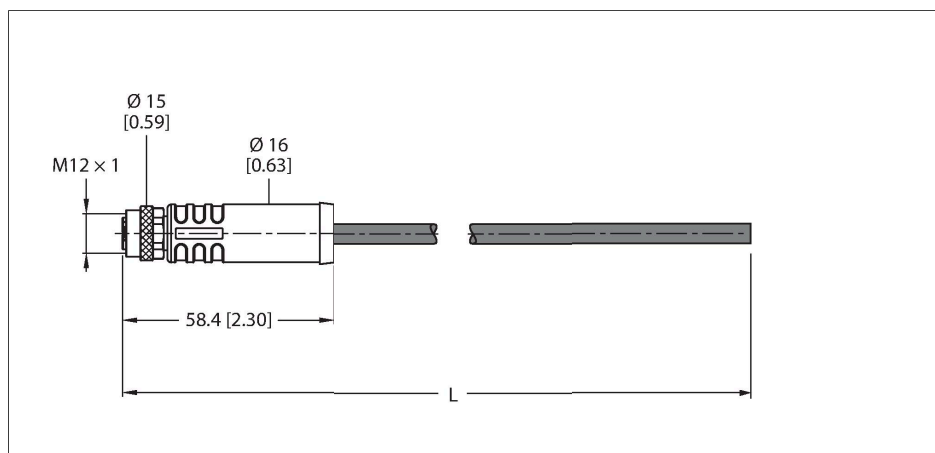

Technical data

Type	RKP56PLA-15/TXG
ID	100038711
Connector A	Female, M12 × 1, Straight, L-coded
Number of Pins	4+FE
Contacts	Brass, CuZn, Gold-plated
Contact carriers	Plastic, PA, Black
Connector body	Plastic, TPU, Black
Coupling nut/screw	Brass, CuZn, Nickel-plated
Seal	Plastic, FPM/FKM
Tightening torque	1 Nm
Mechanical lifespan	> 100 Mating cycles
Pollution degree	3
Protection class	IP65, IP67, IP68, Only in screwed condition
Cable	
Cable diameter	Ø 9.9 mm ±0.20
Cable length	15 m
Cable jacket	PUR, Gray
Core insulation	PP
Core cross-section	5 x 1.5 mm ²
Core colors	BN, WH, BU, BK, GY
Electrical properties at +20 °C	
Rated voltage	50 V _{AC} /63 V _{DC}
Current	16 A
Mechanical and chemical properties	
Bending radius (stationary installation)	≥ 4 x Ø
Bending radius (flexible use)	≥ 8 x Ø
Bending cycles	≥ 8 million

Features



- M12 female connector, L-coded, straight, 5-pin (4+FE)
- Jacket material: PUR
- Jacket color: gray
- Highly resistant to oils, coolants, lubricants
- Suitable for drag chain use
- Resistant to vibrations and shocks
- Flame retardant
- Halogen free
- Norms: CE, UKCA and RoHS
- Protection class: IP65, IP67, IP68
- Cable length: 15 m

Cable Cross-Section

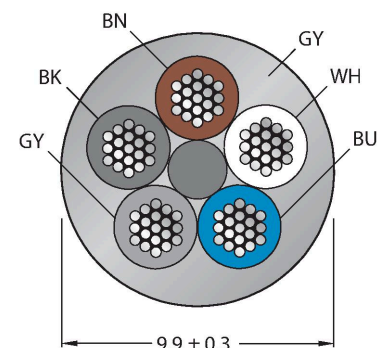

Contact assignment

Technical data

Admissible acceleration	max. 5 m/s ²
Admissible travel path, horizontal	5 m (at 5 m/s ²)
Torsional stress	± 270 °/m
Ambient temperature range (stationary)	-40...+80 °C
Ambient temperature range (In motion)	-30...+80 °C
Ambient temperature during drag chain operation	-25...+60 °C
Qualified for drag chain use	yes
Halogen-free	yes
Oil-resistant	yes
Flame-retardant	yes

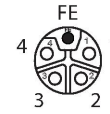

Circuit Diagram



Derating Curve

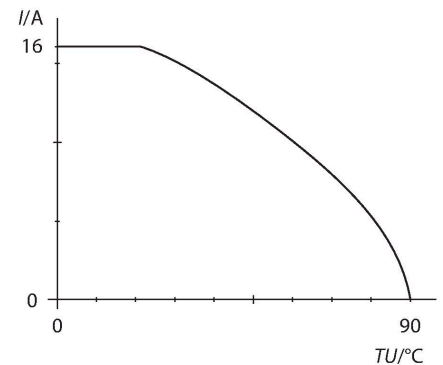

Accessories

Dimension drawing	Type	ID	
	LABEL-HOLDER-FLEX-PVC	100048170	PVC label holder for identification of extension cables (TEL/TXL product series); for cable diameters: min. 5 mm; dimensions 4 × 18 mm; delivery unit: 50 pcs. per package
	VH2-M12L-M5-2F5	100028587	Small h-splitter, M12 Power, L-coded, 4-pin + FE
	VH3-M12L-M5-3F5	100028591	Large H-splitter, M12 Power, L-coded, 4-pin + FE
	VT2-M12L-M5-2F5	100028579	T-splitter, M12 Power, L-coded, 4-pin + FE
	FW-ERSPM0514-PL-S-0813	100008140	Field-wireable male connector, M12 Power, L-coded, straight, 4-pin + FE, screw terminal connection, cable feedthrough 8.0 to 13 mm, core cross-section/terminal capacity 1.5 to 2.5 mm ² , plastic housing, metal retaining screw