

# PKG3M-5/TXL/1025

## Actuator and Sensor Cable, PUR – Connection Cable

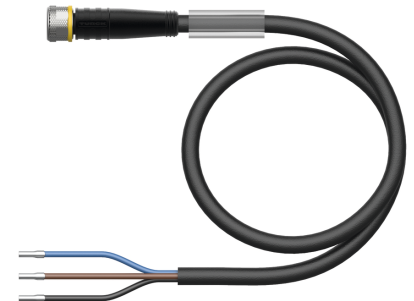
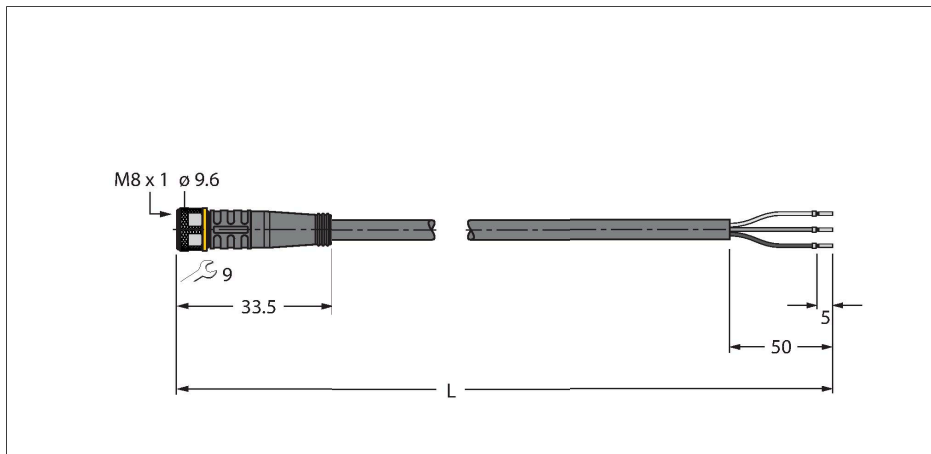

### Technical data

Type	PKG3M-5/TXL/1025
ID	6635907
Connector A	Female, M8 × 1, Straight
Number of Pins	3
Contacts	Brass, CuZn, Gold-plated
Contact carriers	Plastic, TPU, Black
Connector body	Plastic, TPU, Black
Coupling nut/screw	Brass, CuZn, Nickel-plated
Seal	Plastic, FPM/FKM
Tightening torque (range)	0.5 ... 0.6 Nm (observe max. torque of mating connector!)
Mechanical lifespan	> 100 Mating cycles
Pollution degree	3
Protection class	IP67, IP69K, Only in screwed condition
<b>Cable</b>	
Cable diameter	±0.20
Cable length	5 m
Cable jacket	PUR, Black
Core insulation	PP
Core cross-section	0.25 mm <sup>2</sup>
Arrangement of strands	32 x 0.1 mm
<b>Electrical properties at +20 °C</b>	
Rated voltage	50 V <sub>AC</sub> /60 V <sub>DC</sub>
Test voltage	2000 V
Current	4 A
Insulation resistance	> 30.5 MΩ/km
forward resistance	max. 57 Ω/km

### Features



- Female M8, straight, 3-pin
- Jacket material: PUR
- Jacket color: black
- Suitable for drag chain use
- Resistant to chemicals, UV radiation and oils
- Flame retardant
- Resistant to welding sparks
- Free from halogen, silicone, PVC and LABS
- Particularly resistant to abrasion
- Protection class: IP67, IP69K
- Cable length: 5.0 m

### Contact assignment

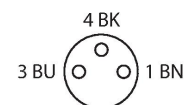

### Circuit Diagram

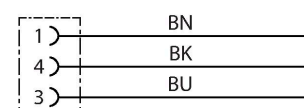

## Technical data

Mechanical and chemical properties	
Bending radius (stationary installation)	$\geq 5 \times \varnothing$
Bending radius (flexible use)	$\geq 10 \times \varnothing$
Bending cycles	$\geq 5$ million
Admissible acceleration	max. 5 m/s <sup>2</sup>
Admissible travel path, horizontal	5 m (at 5 m/s <sup>2</sup> )
Admissible travel path, vertical	2 m (at 5 m/s <sup>2</sup> )
Admissible traversing speed	3.3 m/s
Torsional stress	$\pm 180$ °/m
Ambient temperature range (stationary)	-50...+80 °C
Ambient temperature range (In motion)	-25...+80 °C
Ambient temperature during drag chain operation	-25...+60 °C
Approvals	cULus

## Accessories

TORQUE-WRENCH-SET-AS	6936170	Torque wrench set; handles with adjustable torque 0.4-1.0 Nm, torque wrench for M8 (SW9), fork wrench for M12 (SW 14)	BLANK-LABEL-FOR-CORDSETS-TEL-TXL	6936206	Label for TEL and TXL cables, length: 18 mm, height: 4 mm, material: polycarbonate (PC), color: white, halogen-free and flame-retardant
HAS5131-0	6905402	Field-wireable male connector, M8 x 1, straight, 3-pin, insulation piercing connection, cable feedthrough 2.5 to 5.1 mm, core cross-section/terminal capacity 0.14 to 0.34 mm <sup>2</sup> , plastic housing, metal nut	BS5133-0	6901012	Konfektionierbarer Stecker, M8 x 1, gerade, 3-polig, Schraubklemmanschluss, Leitungsdurchlass 3.5 bis 5.0 mm, Adernquerschnitt/ Klemmvermögen 0.14 bis 0.50 mm <sup>2</sup> , Kunststoffgehäuse, Metallüberwurfschraube
HS5131-0	6902710	Field-wireable male connector, M8 x 1, straight, 3-pin, pressfit technology, cable feedthrough 4.0 to 5.0 mm, core cross-section/terminal capacity 0.14 to 0.34 mm <sup>2</sup> , plastic housing, metal nut	HS5231-0	6902810	Field-wireable male connector, M8 x 1, angled, 3-pin, pressfit technology, cable feedthrough 4.0 to 5.0 mm, core cross-section/terminal capacity 0.14 to 0.34 mm <sup>2</sup> , plastic housing, metal nut

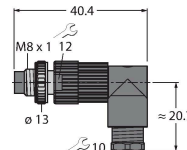
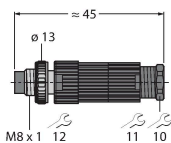
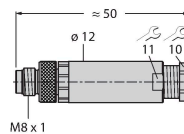
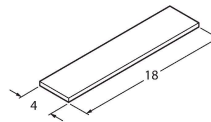
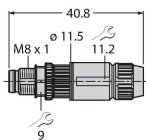

FW-PRKPM0320-SA-S-0406

10002292

Field-wireable female connector, M8 × 1, straight, 3-pin, screw terminal connection, cable feedthrough 4.0 to 5.5 mm, core cross-section/terminal capacity 0.14 to 0.5 mm<sup>2</sup>, plastic housing, metal coupling nut

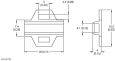

## Accessories

Dimension drawing	Type	ID	
	LABEL-HOLDER-FLEX-PVC	100048170	PVC label holder for identification of extension cables (TEL/TXL product series); for cable diameters: min. 5 mm; dimensions 4 × 18 mm; delivery unit: 50 pcs. per package