

QS30FF200

Photoelectric Sensor – Diffuse Mode Sensor with Fixed-Field Background Suppression

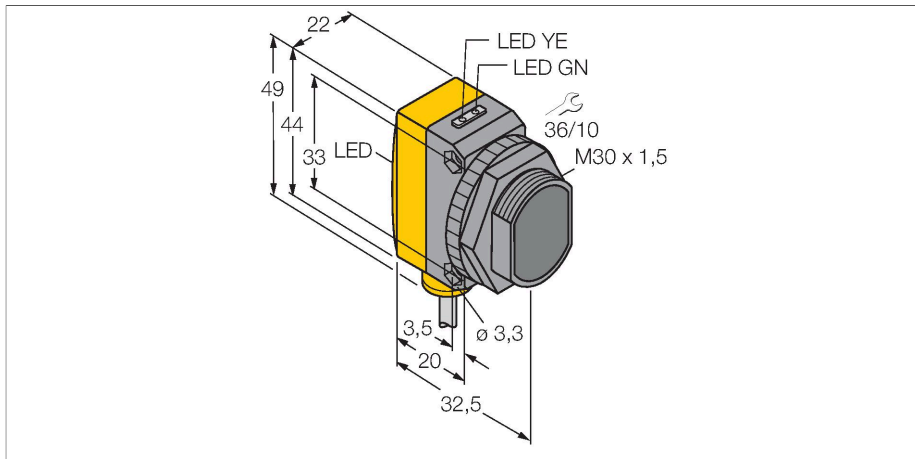

Technical data

Type	QS30FF200
ID no.	3072546
Optical data	
Function	Proximity switch
Operating mode	Background suppression, non-adjustable
Light type	Red
Wavelength	680 nm
Range	0...200 mm
Electrical data	
Operating voltage	10...30 VDC
Residual ripple	< 10 % U _{ss}
DC rated operational current	≤ 150 mA
No-load current	≤ 35 mA
Short-circuit protection	yes
Reverse polarity protection	yes
Output function	NO contact, PNP/NPN
Switching frequency	≤ 250 Hz
Readiness delay	≤ 100 ms
Response time typical	< 2 ms
Mechanical data	
Design	Rectangular with thread, QS30
Dimensions	Ø 30 x 35 x 22 x 49 mm
Housing material	Plastic, Thermoplastic material, Yellow
Lens	plastic, Acrylic
Electrical connection	Cable, 2 m, PVC
Number of cores	5

Features

- Cable, PVC, 2 m
- Protection class IP67
- LED all-round visible
- Operating voltage: 10...30 VDC
- Switching output, bipolar
- Light or dark operation

Wiring diagram

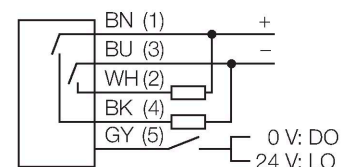

Functional principle

Diffuse mode sensors with background suppression operate with a single emitter and several receiver elements. The target position and the photoelectric structure of the sensor determine which of the receiving elements receives the most light. The sensor electronics determine whether the reflecting object is within or outside the measuring range. These sensors come with a fixed cut-off point.

Excess gain curve
Excess gain in relation to the distance

Technical data

Core cross-section	0.5 mm ²
Ambient temperature	-20...+70 °C
Protection class	IP67
Power-on indication	LED, Green
Switching state	LED, Yellow
Error indication	LED, green, Flashing
Excess gain indication	LED, yellow
Tests/approvals	
MTTF	177 years acc. to SN 29500 (Ed. 99) 40 °C
Approvals	CE

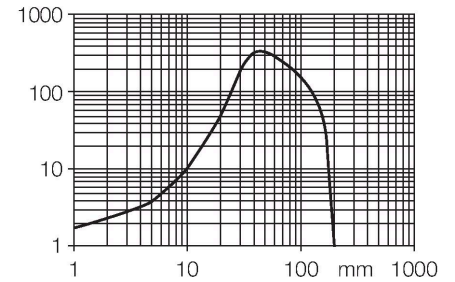

Accessories

