

# DX80G2M6-Q

## Radio Transmission System – Star Topology Gateway

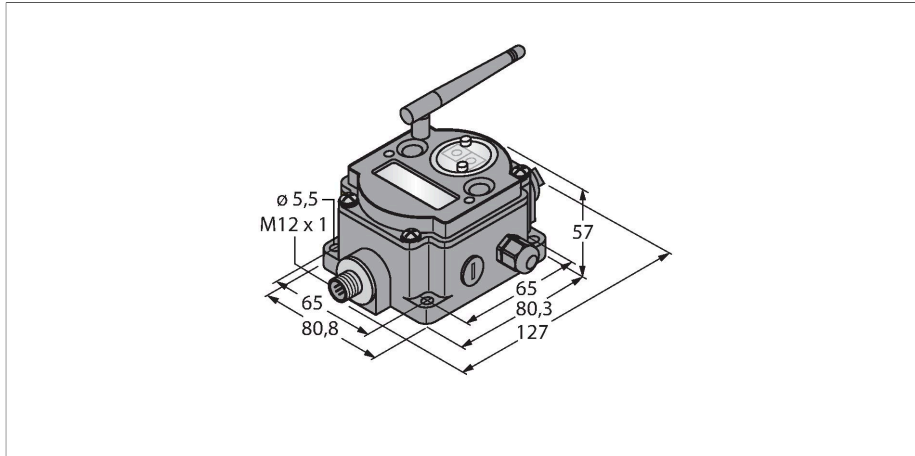

### Features

- External antenna (RG58 RP-SMA connection)
- Integrated signal strength indicator
- Configuration via DIP switch
- Modbus RTU communication, RS485 interface
- Selectable connection of DX80 nodes and/or Q45 sensors
- Deterministic data transmission
- Frequency hopping FHSS
- Time Division Multiplex Access TDMA
- Transmission power: 63 mW, 18 dBm conducted, ≤ 20 dBm EIRP
- Inputs: 6 x PNP
- Outputs: 6 x PNP
- Power consumption: < 60 mA at 24 VDC

### Technical data

Type	DX80G2M6-Q
ID	3025894
<b>Wireless data</b>	
Type of radio	short-range
Installation	stationary
Topology	Star topology
Function	Star topology
Device type	Gateway
Frequency band	2.4-GHz ISM band
Frequency range	2.402 - 2.483 GHz
Number of radio channels	50
Channel width	1 MHz
Spread spectrum technology	FHSS (Frequency Hopping Spread Spectrum)
Single-Carrier Residence Time	7.8 ms
Response time typical	< 62.5 ms
Output power ERP	18 dB/65 mW
Output power EIRP	20 dB/100 mW
<b>I/O data</b>	
Number of channels	6
Input type	PNP
Number of channels	6
Output type	PNP
Communication protocol	Modbus RTU RS485

### Wiring diagram

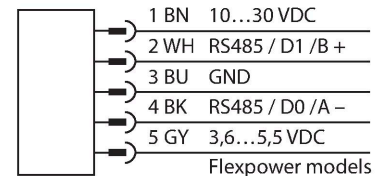

### Functional principle

DX80 gateway for connection of Q45 wireless sensors. Networked in star topology. DX80 nodes can also be used alongside the Q45 sensors. Depending on the number of Q45 sensors used, a switching output and an alarm output is provided on the gateway for each Q45 sensor. When connected to Modbus RTU, up to 47 of these nodes can be coupled. In all other aspects, the network behaves like a normal DX80 network.

Directives:  
 FCC-ID UE300DX80-2400- This device complies with FCC para. 15, subpara. C, 15.247 ETSI/EN: In compliance with EN 300 328: V2.2.2 (2019-02) IC: 7044A-DX8024  
 Radiation protection 10 V/m for 80–2700 MHz acc. to EN 61000-6-2  
 Shock and vibration resistance: IEC 68-2-6 and IEC 68-2-7

## Technical data

Electrical data	
runs with battery	nein
Operating voltage	10...30 VDC
DC rated operational current	≤ 60 mA
Power-on indication	LED, Green
Mechanical data	
Design	Rectangular, DX80
Dimensions	127 x 80.8 x 57 mm
Housing material	Plastic, PC
Antenna connection	RP-SMA female connector
Ambient temperature	-20...+80 °C
Relative humidity	0...95 %
Protection class	IP67
Tests/approvals	







## Accessories

SMBDX80DIN	3077161
------------	---------



Mounting panel for DIN rail, suited for CP80, DX80, K80, Q80, operating temperature: -20...90 °C

## Accessories

Dimension drawing	Type	ID	
Keine Maßzeichnung vorhanden! No drawing available!	BWC-LMRSFRPB	3079296	Surge protection, bulkhead fitting, RP-SMA type
	BWC-1MRSFRSB0.2	3078544	Antenna extension, RP-SMA on RP-SMAF bulkhead fitting, 0.2m, RG58, loss 1.05 dB/m
	BWC-1MRSFRSB1	3078337	Antenna extension, RP-SMA on RP-SMAF bulkhead fitting, 1 m, RG58, loss 1.05 dB/m
	BWC-1MRSFRSB2	3078338	Antenna extension, RP-SMA on RP-SMAF bulkhead fitting, 2m, RG58, loss 1.05 dB/m

Dimension drawing	Type	ID	
	BWC-1MRSFRSB4	3077488	Antenna extension, RP-SMA on RP-SMAF bulkhead fitting, 4m, RG58, loss 1.05 dB/m
	BWC-1MRSMN05	3077486	Antenna extension, RP-SMA on N-male, 0.5 m, RG58, loss 0.56 dB/m
	BWC-1MRSMN2	3077820	Antenna extension, RP-SMA on N-male, 2m, RG58, loss 0.56 dB/m
	BWC-4MNFN3	3077489	Antenna extension, N male connector to N female connector, cable length: 3 m, LMR400, coaxial, loss: 0.22 dB/m
	BWC-4MNFN6	3077490	Antenna extension, N-male on N-female, 6m, LMR400, coaxial, loss 0.22 dB/m
	BWC-4MNFN15	3077821	Antenna extension, N-male on N-female, 15 m, LMR400, coaxial, loss 0.22 dB/m
	BWC-4MNFN30	3077822	Antenna extension, N-male on N-female, 30m, LMR400, coaxial, loss 0.22 dB/m

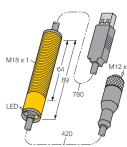
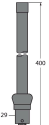
## Accessories

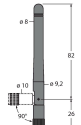
Dimension drawing	Type	ID	
	BWA-HW-006	3081325	Converter cable, RS485 to USB 2.0 converter, female connector, M12 x 1, 5-pin, male connector, USB type A, length 1 m; supplies the connected device with 10 V. An external power supply via a Y-splitter (6634679) is recommended for the connected device
	BWA-2O6-A	3081081	External antenna 6 dBi, N-female
	BWA-2O8-A	3081080	External antenna 8.5 dBi, N-female
	BWA-2O2-C	3077816	Internal antenna 2 dBi, RP-SMA male, standard

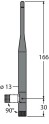
Dimension drawing	Type	ID	
	BWA-205-C	3077817	Internal antenna 5 dBi, RP-SMA male
	BWA-207-C	3077818	Internal antenna 7 dBi, RP-SMA male