

QS18VP6LDQ

Photoelectric Sensor – Diffuse Mode Laser Sensor

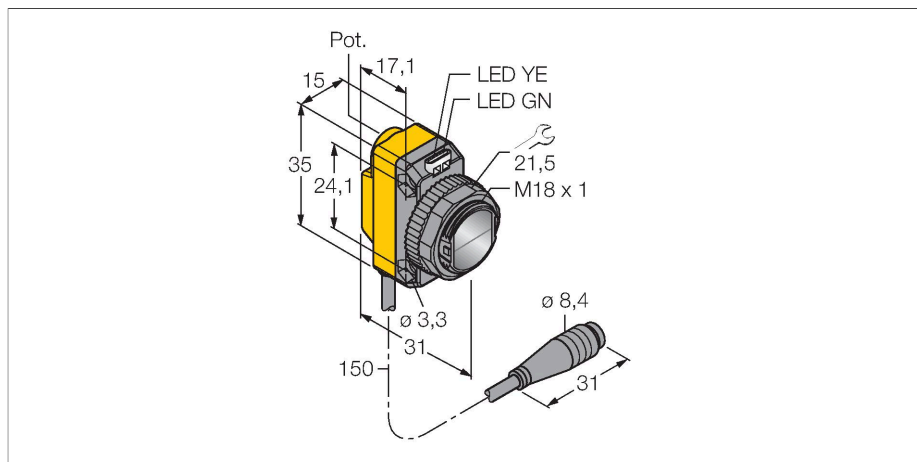

Technical data

Type	QS18VP6LDQ
ID no.	3073042
Optical data	
Function	Proximity switch
Operating mode	Diffuse
Light type	Red
Wavelength	650 nm
Laser class	▲ 1
Beam diameter	1 mm at 300 mm
Range	0...300 mm
Electrical data	
Operating voltage	10...30 VDC
Residual ripple	< 10 % U _{ss}
DC rated operational current	≤ 100 mA
No-load current	≤ 15 mA
Short-circuit protection	yes
Reverse polarity protection	yes
Output function	NO/NC, PNP
Current output	100 mA
Switching frequency	≤ 700 Hz
Readiness delay	≤ 200 ms
Response time typical	< 0.7 ms
Setting option	Potentiometer
Mechanical data	
Design	Rectangular with thread, QS18
Dimensions	Ø 18 x 31 x 15 x 35 mm
Housing material	Plastic, ABS

Features

- Cable with male end, 4-pin, PVC, 150 mm, 8 mm
- Protection class IP67
- LED all-round visible
- Sensitivity adjusted via potentiometer
- Operating voltage: 10...30 VDC
- PNP switching output, changeover

Wiring diagram

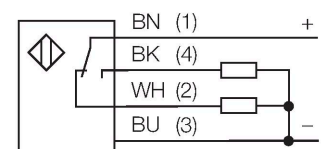

Functional principle

Identical to retro-reflective sensors, emitter and receiver circuitry are incorporated in the same housing of the diffuse mode sensors. However, diffuse mode sensors do not detect the interruption of the light beam but the reflection of the target. A target is detected if it reflects sufficient light back to the receiver. The switching distance of diffuse mode sensors thus largely depends on the reflectivity of the target.

Excess gain curve
Excess gain in relation to the distance

Technical data

Lens	plastic, Acrylic
Electrical connection	Cable with connector, M8 × 1, 0.15 m, PVC
Number of cores	4
Ambient temperature	-10...+50 °C
Protection class	IP67
Special features	Laser
Power-on indication	LED, Green
Switching state	LED, Yellow
Error indication	LED, green, Flashing
Excess gain indication	LED, yellow, flashing
Tests/approvals	
MTTF	17 years acc. to SN 29500 (Ed. 99) 40 °C
Approvals	CE, cURus

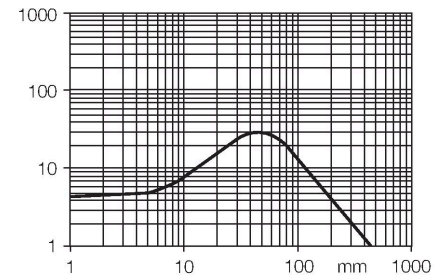

Accessories

SMB18A

3033200

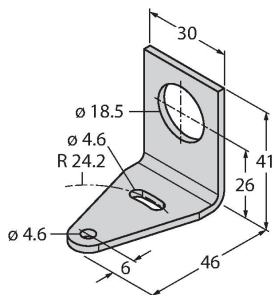

Mounting bracket, rectangular, stainless steel, for sensors with 18 mm thread

SMB18AFAM10

3012558

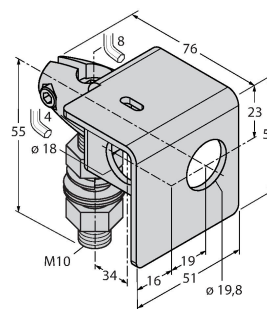

Mounting bracket, material VA 1.4401, for M10 x 1.5 thread, thread length 18 mm

SMBQS18A

3069721

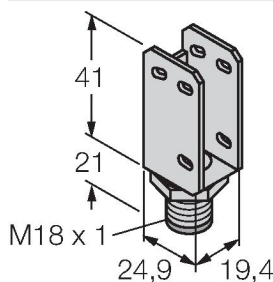

Mounting bracket, stainless steel, for 18 mm thread

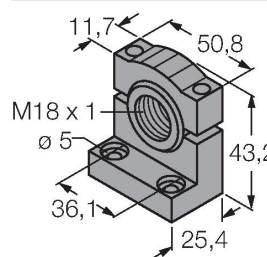

SMB18SF

3052519

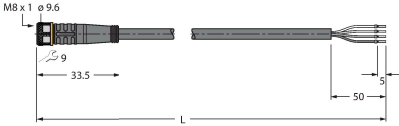

Mounting bracket, PBT black, for sensors with 18 mm thread, rotatable

Accessories

Dimension drawing	Type	ID no.	
	PKG4M-2/TEL	6625061	Connection cable, female M8, straight, 4-pin, cable length: 2 m, sheath material: PVC, black; cULus approval; other cable lengths and qualities available, see www.turck.com
	PKW4M-2/TEL	6625067	Connection cable, female M8, angled, 4-pin, cable length: 2 m, sheath material: PVC, black; cULus approval; other cable lengths and qualities available, see www.turck.com