

RSC4T-20/TXY

Actuator and Sensor Cable, PUR – Connection Cable

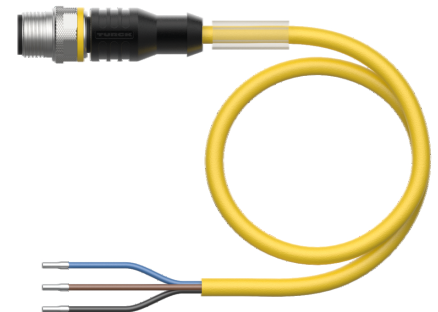
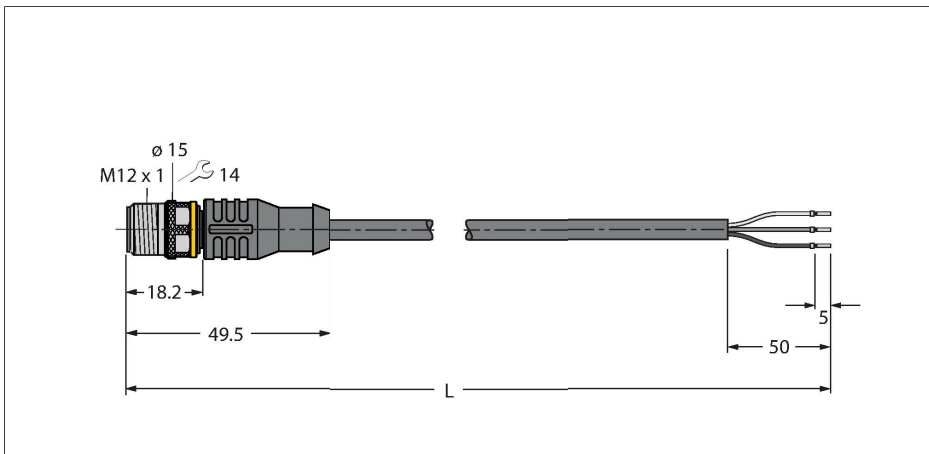

Technical data

| | |
|-------------------------------------------|----------------------------------------|
| Type | RSC4T-20/TXY |
| ID | 6635546 |
| Connector A | Male, M12 × 1, Straight, A-coded |
| Number of Pins | 3 |
| Contacts | Brass, CuZn, Gold-plated |
| Contact carriers | Plastic, TPU, Black |
| Connector body | Plastic, TPU, Black |
| Coupling nut/screw | Brass, CuZn, Nickel-plated |
| Mechanical lifespan | > 100 Mating cycles |
| Pollution degree | 3 |
| Protection class | IP67, IP69K, Only in screwed condition |
| Cable | |
| Cable diameter | Ø 4.1 mm ±0.20 |
| Cable length | 20 m |
| Cable jacket | PUR, Yellow |
| Core insulation | PP |
| Core cross-section | 3 x 0.34 mm ² |
| Arrangement of strands | 42 x 0.1 mm |
| Core colors | BN, BU, BK |
| Electrical properties at +20 °C | |
| Rated voltage | 250 V |
| Test voltage | 2000 V |
| Current | 4 A |
| Insulation resistance | > 30.5 MΩ/km |
| forward resistance | max. 57 Ω/km |
| Mechanical and chemical properties | |
| Bending radius (stationary installation) | ≥ 5 x Ø |

Features



- Male M12, straight, 3-pin
- Jacket material: PUR
- Jacket color: yellow
- Suitable for drag chain use
- Resistant to chemicals, UV radiation and oils
- Flame retardant (FT2 acc. to UL 1581, IEC 60332-2-2)
- Resistant to welding sparks
- Free from halogen, silicone, PVC and LABS
- Particularly resistant to abrasion
- Protection class: IP67, IP69K
- Cable length: 20 m

Cable Cross-Section

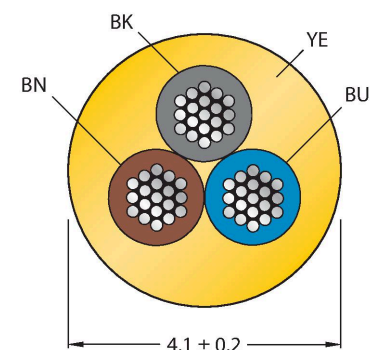

Contact assignment

Technical data

| | |
|-------------------------------------------------|-------------------------------|
| Bending radius (flexible use) | $\geq 10 \times \varnothing$ |
| Bending cycles | ≥ 5 million |
| Admissible acceleration | max. 5 m/s^2 |
| Admissible travel path, horizontal | 5 m (at 5 m/s^2) |
| Admissible travel path, vertical | 2 m (at 5 m/s^2) |
| Admissible traversing speed | 3.3 m/s |
| Torsional stress | $\pm 180^\circ/\text{m}$ |
| Ambient temperature range (stationary) | $-50 \dots +80^\circ\text{C}$ |
| Ambient temperature range (In motion) | $-25 \dots +80^\circ\text{C}$ |
| Ambient temperature during drag chain operation | $-25 \dots +60^\circ\text{C}$ |
| Approvals | cULus |

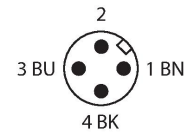

Circuit Diagram

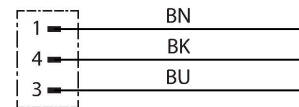

Accessories

TORQUE-WRENCH-SET-AS 6936170

Torque wrench set; handles with adjustable torque 0.4-1.0 Nm, torque wrench for M8 (SW9), fork wrench for M12 (SW 14)

BLANK-LABEL-FOR-CORDSETS-TEL-TXL 6936206

Label for TEL and TXL cables, length: 18 mm, height: 4 mm, material: polycarbonate (PC), color: white, halogen-free and flame-retardant

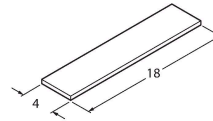

HA8141-0 6905407

Field-wireable female connector, M12 × 1, straight, 4-pin, insulation piercing connection, cable feedthrough 4.0 to 5.1 mm, core cross-section/terminal capacity 0.14 to 0.34 mm², plastic housing, metal nut

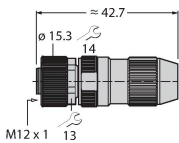

HA8241-0 6905401

Field-wireable female connector, M12 × 1, angled, 4-pin, insulation piercing connection, cable feedthrough 4.0 to 5.1 mm, core cross-section/terminal capacity 0.14 to 0.34 mm², plastic housing, metal nut

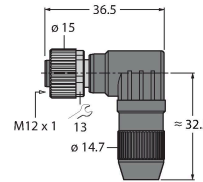

B8141-0 69049

Field-wireable female connector, M12 × 1, straight, 4-pin, screw terminal connection, cable feedthrough 4.0 to 6.0 mm, core cross-section/terminal capacity 0.14 to 0.75 mm², plastic housing, plastic nut

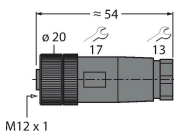

B8241-0 69048

Field-wireable female connector, M12 × 1, angled, 4-pin, screw terminal connection, cable feedthrough 4.0 to 6.0 mm, core cross-section/terminal capacity 0.14 to 0.75 mm², plastic housing, plastic nut

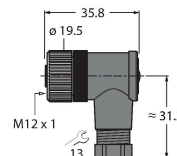

BM8141-0

6935145

Field-wireable female connector, M12 × 1, straight, 4-pin, screw terminal connection, cable feedthrough 4.0 to 6.0 mm, core cross-section/terminal capacity 0.25 to 0.75 mm², plastic housing, metal nut

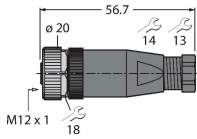

BM8241-0

6935889

Field-wireable female connector, M12 × 1, angled, 4-pin, screw terminal connection, cable feedthrough 4.0 to 6.0 mm, core cross-section/terminal capacity 0.25 to 0.75 mm², plastic housing, metal nut

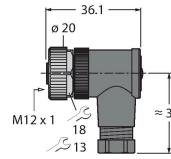

Accessories

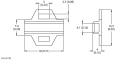
| Dimension drawing | Type | ID | |
|-----------------------------------------------------------------------------------|-----------------------|-----------|----------------------------------------------------------------------------------------------------------------------------------------------------------------------------|
|  | LABEL-HOLDER-FLEX-PVC | 100048170 | PVC label holder for identification of extension cables (TEL/TXL product series); for cable diameters: min. 5 mm; dimensions 4 × 18 mm; delivery unit: 50 pcs. per package |