

SM312D W/30'

Photoelectric Sensor – Diffuse Mode Sensor

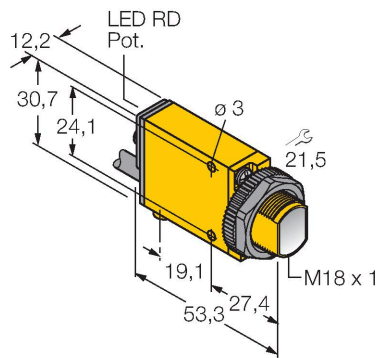

Features

- Cable, PVC, 2 m
- Protection class IP67
- Sensitivity adjustable via potentiometer
- Alignment indicator
- Operating voltage: 10...30 VDC
- Switching output, bipolar
- Light/dark operation

Wiring diagram

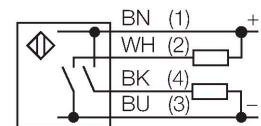

Technical data

Type	SM312D W/30'
ID no.	3001930
Optical data	
Function	Diffuse mode sensor
Light type	IR
Wavelength	880 nm
Range	0...380 mm
Electrical data	
Operating voltage	10...30 VDC
Residual ripple	< 10 % U_{ss}
DC rated operational current	≤ 150 mA
No-load current	≤ 25 mA
Output function	NO contact, PNP/NPN
Switching frequency	≤ 500 Hz
Overcurrent release	> 220 mA
Mechanical data	
Design	Rectangular, Mini Beam
Dimensions	53.3 x 12.3 x 30.7 mm
Housing material	Plastic, PBT, Yellow
Lens	plastic, Acrylic
Electrical connection	Cable, 2 m, PVC
Number of cores	4
Core cross-section	0.5 mm ²
Ambient temperature	-20...+70 °C
Protection class	IP67
Switching state	LED, Red
Excess gain indication	LED, red, flashing

Functional principle

Diffuse mode sensors incorporate the emitter and receiver in a single housing. However, diffuse mode sensors do not detect the interruption of the light beam like opposed mode sensors, but the reflection of the target. A target is detected if it reflects a sufficient amount of light back to the receiver. The switching distance of diffuse mode sensors thus largely depends on the reflectivity of the target.

Excess gain curve
Excess gain in relation to the distance

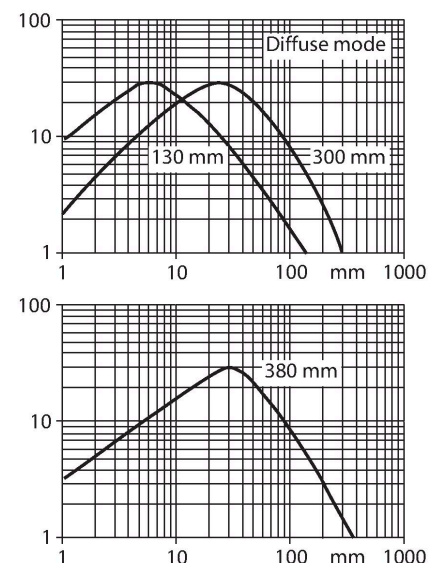

Technical data

Tests/approvals

Approvals

CE, cURus, CSA

Accessories

SMB18A

3033200

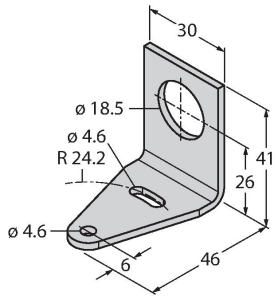

Mounting bracket, rectangular, stainless steel, for sensors with 18 mm thread

SMB18AFAM10

3012558

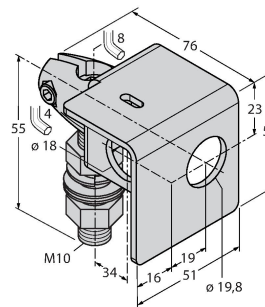

Mounting bracket, material VA 1.4401, for M10 x 1.5 thread, thread length 18 mm

SMB18SF

3052519

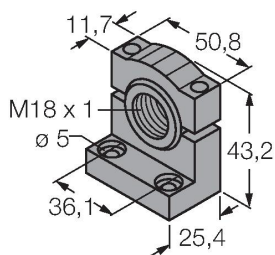

Mounting bracket, PBT black, for sensors with 18 mm thread, rotatable

SMB312B

3025519

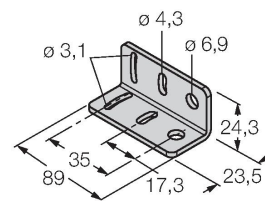

Mounting bracket, stainless steel, for MINI-BEAM NAMUR

SMB3018SC

3053952

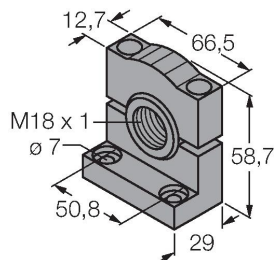

Mounting bracket, PTB black, for sensors with 18 mm thread