

# DF-G2-PC-Q7

## Photoelectric Sensor – Photoelectric Sensor for Plastic Fibers

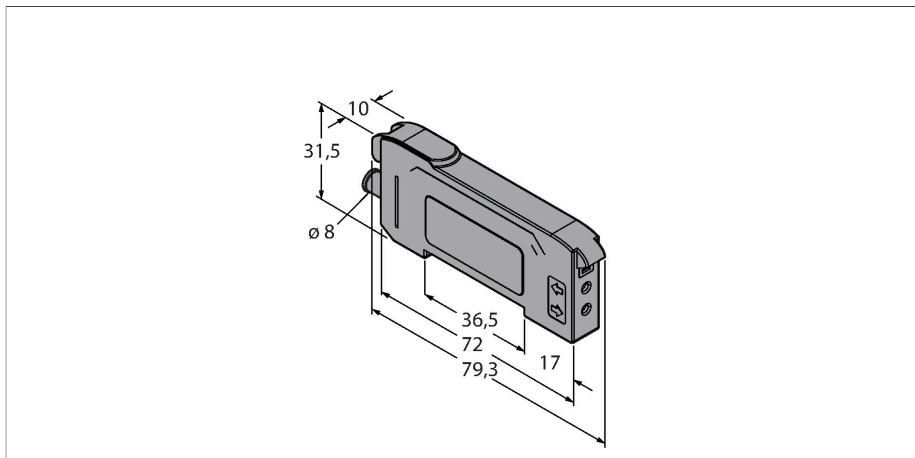

### Technical data

Type	DF-G2-PC-Q7
ID no.	3087570
<b>Optical data</b>	
Function	Photoelectric sensor for plastic fibers
Light type	Red
Wavelength	635 nm
<b>Electrical data</b>	
Operating voltage	10...30 VDC
Residual ripple	< 10 % U <sub>ss</sub>
DC rated operational current	≤ 40 mA
Short-circuit protection	yes
Reverse polarity protection	yes
Output function	NO contact, PNP
Current output	100 mA
Switching frequency	50 kHz
Readiness delay	≤ 500 ms
Response time typical	< 0.01 ms
Setting option	Push Button Remote Teach
<b>Mechanical data</b>	
Design	Rectangular, DF-G1
Dimensions	79.3 x 10 x 33 mm
Housing material	Plastic, Thermoplastic material, Black
Electrical connection	Connectors, M8 × 1, PVC
Number of cores	5
Ambient temperature	-10...+55 °C
Relative humidity	0...90 %

### Features

- Male connector, 8 mm, 4-pin
- Visible red light
- Programming via teach cable or multi-function button
- Operating voltage: 10...30 VDC
- PNP output
- Light/dark operation

### Wiring diagram

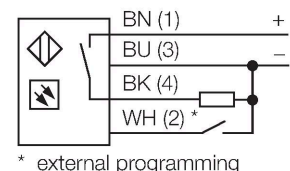

### Functional principle

Glass or plastic fibers are the optimum choice for high-temperature applications and limited spaces. Optical fibers transfer the light from the sensor to a remote object. Single optical fibers are suited for opposed sensing mode, while bifurcated optical fibers are best suited for diffuse sensing mode.

## Technical data

Protection class	IP50
Special features	Small part counting keep/defer Crosstalk protection
Switching state	LED, Yellow
Excess gain indication	Dual Digital Displays
<b>Tests/approvals</b>	
Approvals	CE, cULus listed

## Accessories

Dimension drawing	Type	ID no.	
	PKG4S-2/TEL	6627370	Connection cable, female Ø M8, straight, 4-pin, snap-on type, cable length: 2 m, jacket material: PVC, black; cULus approval; other cable lengths and qualities available, see <a href="http://www.turck.com">www.turck.com</a>
	PKW4S-2/TEL	6627373	Connection cable, Ø 8 mm female, snap-on type, angled, 4-pin, cable length: 2 m, jacket material: PVC, black; cULus approval; other cable lengths and qualities available, see <a href="http://www.turck.com">www.turck.com</a>

## Accessories

Dimension drawing	Type	ID no.	
	PBT16U	3042822	Plastic fiber-optic sensor, operating mode: Diffuse mode, threaded sleeve M3 x 0.75 mm, field wireable wire without end tip, polyethylene sheath, ambient temperatures -30 °C...+70 °C
	PBT26U	3026080	Plastic fiber, sensing mode: Diffuse mode, threaded bush M3 x 0.75 mm, preassembled wire without end tip, polyethylene jacket, ambient temperatures -30 °C...+70 °C

Dimension drawing	Type	ID no.	
	PBT46U	3025967	Plastic fiber-optic sensor, operating mode: Diffuse mode, threaded sleeve M3 x 0.75 mm, field wireable wire without end tip, polyethylene sheath, ambient temperatures -30 °C...+70 °C

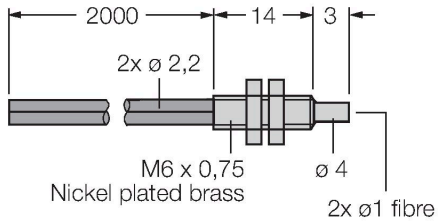

PBT66U	3039982
--------	---------

Plastic fiber-optic sensor, operating mode: Diffuse mode, threaded sleeve M6 x 0.75 mm, pre-assembled wire without end tip, polyethylene sheath, ambient temperatures -30 °C...+70 °C

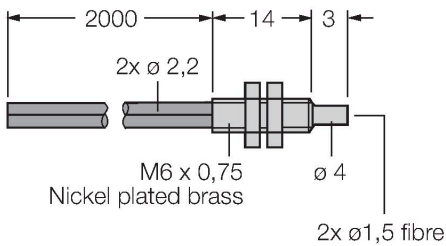

PIT16U	3039983
--------	---------

Plastic fiber-optic sensor, operating mode: Opposed mode, threaded sleeve M3 x 0.5 mm, field wireable wire without end tip, polyethylene sheath, ambient temperatures -30 °C...+70 °C

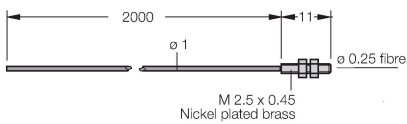

PIT26U	3026079
--------	---------

Plastic fiber, sensing mode: Opposed mode, threaded bush M3 x 0.5 mm, preassembled wire without end tip, polyethylene jacket, ambient temperatures -30 °C...+70 °C

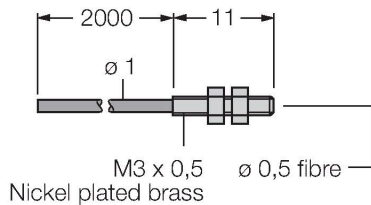

Dimension drawing	Type	ID no.	
	PIT46U	3026034	Plastic fiber-optic sensor, operating mode: Opposed mode, threaded sleeve M3 x 0.5 mm, field wireable wire without end tip, polyethylene sheath, ambient temperatures -30 °C...+70 °C

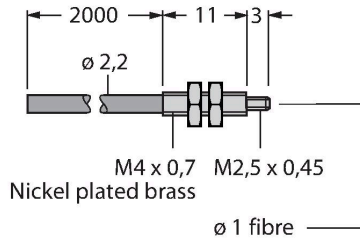

	PIT66U	3039899	Plastic fiber-optic sensor, operating mode: Opposed mode, threaded sleeve M3 x 0.5 mm, field wireable wire without end tip, polyethylene sheath, ambient temperatures -30 °C...+70 °C
--	--------	---------	---

