

WKH4.5-25/TFG

Food & Beverage Hygienic, TPE – Connection Cable

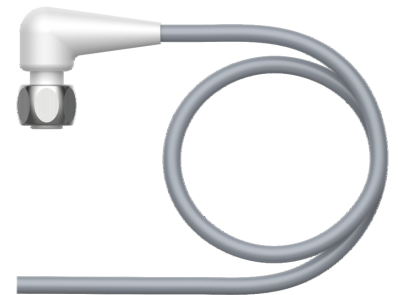
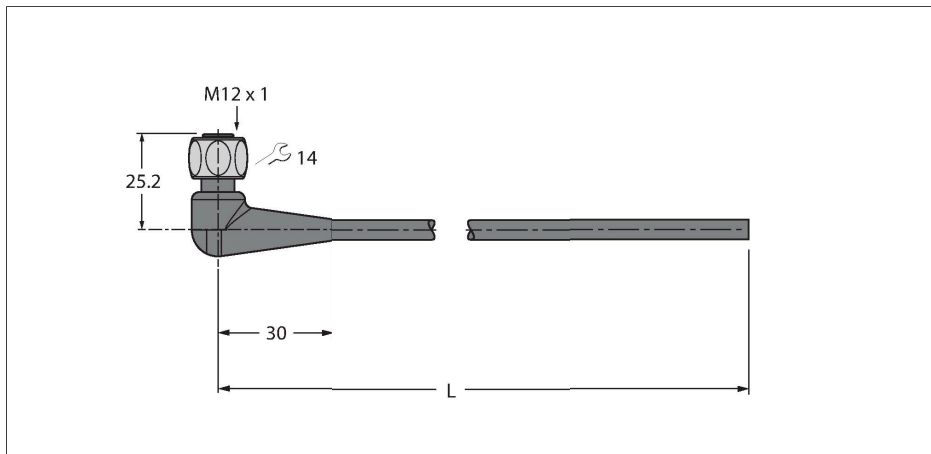

Technical data

Type	WKH4.5-25/TFG
ID	6933865
Connector A	Female, M12 × 1, Angled
Number of Pins	5
Contacts	Brass, CuZn, Gold-plated
Contact carriers	Plastic, PP, Gray
Connector body	Plastic, PP, Gray
Coupling nut/screw	Stainless Steel, V4A
Seal	Plastic, FPM/FKM
Tightening torque (range)	0.8 ... 1 Nm (observe max. torque of mating connector!)
Mechanical lifespan	> 100 Mating cycles
Pollution degree	3
Protection class	IP65, IP67, IP68, IP69, Only in screwed condition
Cable	
Cable diameter	Ø 5 mm ±0.15
Cable length	25 m
Cable jacket	TPE-O, Gray
Core insulation	TPE-E
Core cross-section	5 x 0.34 mm ²
Arrangement of strands	42 x 0.1 mm
Core colors	BN, BU, BK, WH, GY
Electrical properties at +20 °C	
Rated voltage	250 V
Test voltage	2000 V
Current	4 A

Features



- M12 female connector, angled, 4-pin
- Stainless steel coupling nut/screw
- Sheath material: TPE-O
- Sheath color: light gray RAL 7035
- Qualified for drag chain use
- Resistant to chemicals and microbes
- Weatherproof
- Resistant to hydrolysis acc. to DIN EN 60068-2-78
- Flexible at low temperatures
- Free from silicone and PVC
- Halogen-free acc. to DIN EN 50267-2-1, IEC 60754-1, VDE 0482-267-2-1
- Approvals: Gost, Ecolab, FDA
- RoHS and REACH compliant
- Protection classes IP67, IP69K
- Cable length: 25 m

Cable Cross-Section

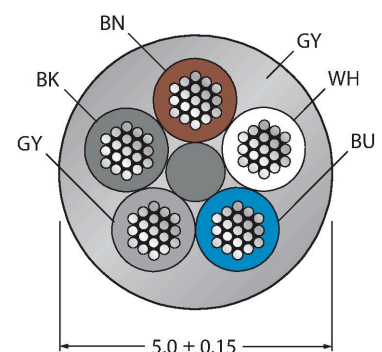

Contact assignment

Technical data

Insulation resistance	$\geq 10^8 \Omega$
Nom. capacitance	82 pF/m
Nom. Inductance	0.73 mH/km
Mechanical and chemical properties	
Max. tensile strength (static)	$\leq 50 \text{ N/mm}^2$
Max. tensile strength (dynamic)	$\leq 20 \text{ N/mm}^2$
Bending radius (stationary installation)	$\geq 5 \times \varnothing$
Bending radius (flexible use)	$\geq 10 \times \varnothing$
Bending cycles	≥ 4 million
Admissible acceleration	max. 5 m/s ²
Admissible travel path, horizontal	5 m (at 5 m/s ²)
Admissible travel path, vertical	2 m (at 5 m/s ²)
Admissible traversing speed	3 m/s
Torsional stress	$\pm 180 \text{ }^\circ/\text{m}$
Ambient temperature range (stationary)	-40...+105 °C
Ambient temperature range (In motion)	-25...+105 °C
Ambient temperature during drag chain operation	-25...+60 °C

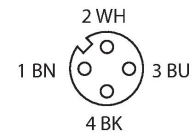

Circuit Diagram



Accessories

TORQUE-WRENCH-SET-AS	6936170
Torque wrench set; handles with adjustable torque 0.4-1.0 Nm, torque wrench for M8 (SW9), fork wrench for M12 (SW 14)	