

Q40SP6FF400Q

Photoelectric Sensor – Diffuse Mode Sensor with Fixed-Field Background Suppression

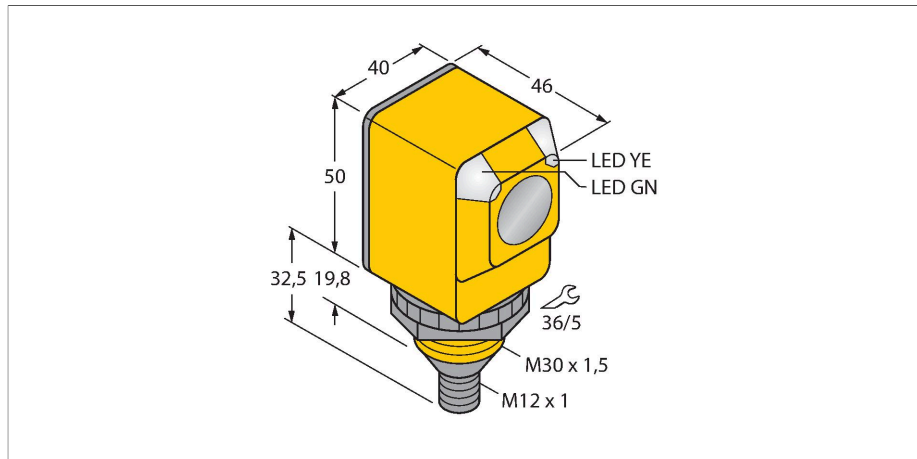

Features

- M12 × 1 male connector, 4-pin
- Protection classes IP67/IP69K
- Ambient temperature: -40 °C...+70 °C
- Operating voltage: 10...30 VDC
- PNP switching output, changeover

Wiring diagram

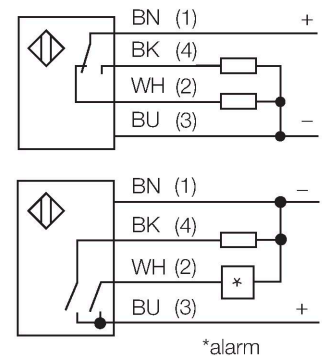

Technical data

Type	Q40SP6FF400Q
ID no.	3033393
Optical data	
Function	Proximity switch
Operating mode	Background suppression, non-adjustable
Light type	IR
Wavelength	880 nm
Range	0...400 mm
Electrical data	
Operating voltage	10...30 VDC
No-load current	≤ 35 mA
Short-circuit protection	yes / Cyclic
Reverse polarity protection	yes
Output function	Connection programmable, PNP
Switching frequency	≤ 160 Hz
Readiness delay	≤ 100 ms
Response time typical	< 3 ms
Overcurrent release	> 220 mA
Mechanical data	
Design	Rectangular, Q40
Dimensions	Ø 30 x 46 x 40.1 x 82.5 mm
Housing material	Plastic, Thermoplastic material
Lens	plastic, Polycarbonate
Electrical connection	Connectors, M12 × 1, PVC
Number of cores	4
Ambient temperature	-40...+70 °C

Functional principle

The emitter and receiver are incorporated in a single housing. The light reflection of the target is detected and triggers the sensor to switch. Thus the switching distance largely depends on the reflectivity of the target.

Excess gain curve

Excess gain in relation to the distance

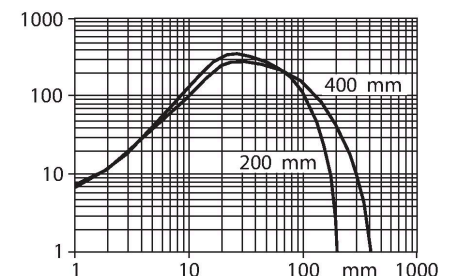

Technical data

Protection class	IP67 IP69
Special features	Encapsulated Wash down
Power-on indication	LED, Green
Switching state	LED, Yellow
Error indication	LED, green, Flashing
Excess gain indication	LED
Alarm display	LED yellow Flashing
Tests/approvals	
MTTF	448 years acc. to SN 29500 (Ed. 99) 40 °C
Approvals	CE, UL, CSA

Accessories

SMB30A

3032723

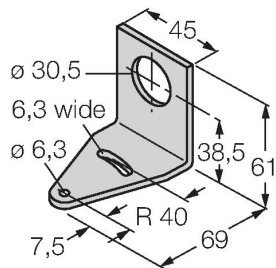

Mounting bracket, rectangular, stainless steel, for sensors with 30mm thread

SMB30FAM10

3011185

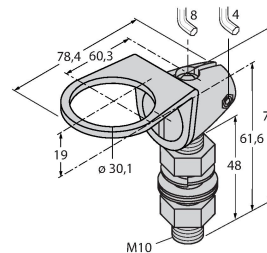

Mounting bracket, stainless steel, for M10 x 1.5 thread, thread length 30 mm

SMB30SC

3052521

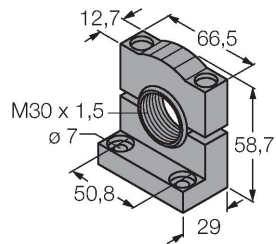

Mounting bracket, PBT black, for sensors with 30 mm thread, rotatable

SMBAMS30P

3073135

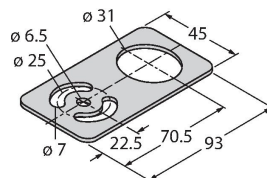

Mounting bracket, stainless steel, for sensors with 30 mm thread

Accessories

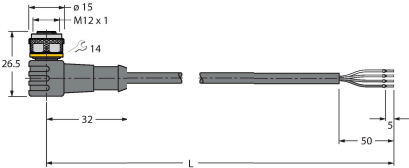
Dimension drawing	Type	ID no.	
	RKC4.4T-2/TEL	6625013	Connection cable, female M12, straight, 4-pin, cable length: 2 m, sheath material: PVC, black; cULus approval; other cable lengths and qualities available, see www.turck.com
	WKC4.4T-2/TEL	6625025	Connection cable, female M12, angled, 4-pin, cable length: 2 m, sheath material: PVC, black; cULus approval; other cable lengths and qualities available, see www.turck.com