

# IVU2PRG906

## Vision Systems – Grayscale Image Sensor



### Technical data

Type	IVU2PRG906
ID	3090936
<b>Camera data</b>	
Function	Gray value
Resolution	752 x 480 Pixels
Light type	UV
Brennweite	4 mm
Special features	Wash down
<b>Electrical data</b>	
Operating voltage	10...30 VDC
DC rated operational current	≤ 1000 mA
Communication protocol	EtherNet/IP Modbus TCP PCCC PROFINET RS232
<b>Mechanical data</b>	
Design	Rectangular, iVu PLUS
Dimensions	51.5 x 81.2 x 95.3 mm
Housing material	Plastic, Thermoplastic material, Black
Window material	Acrylic, clear
Electrical connection	Connector, M12 × 1, 12-wire
Display	Remote
Ambient temperature	0...+50 °C
Protection class	IP67
<b>Tests/approvals</b>	
Approvals	CE

### Features

- Second iVu generation
- Internal memory for 30 inspections
- 1/3" CMOS, 752x480 pixels
- Integrated ring light: UV light (365 nm)
- Protection class IP67
- External strobe output + 5 VDC
- External trigger input
- Lens, 6mm, M12x1
- External display RDM35 required
- Operating voltage 10...30 VDC
- M12 × 1 male, 12-pin
- 3 x programmable switching output (PNP/ NPN)
- 1 x RS232 data communication
- Ethernet via M8 x 1 male, 4-pin
- USB 2.0 host: M8 female, 4-pin
- Industrial Ethernet: PROFINET, Ether-Net/IP, Modbus/TCP, PCCC

### Wiring diagram

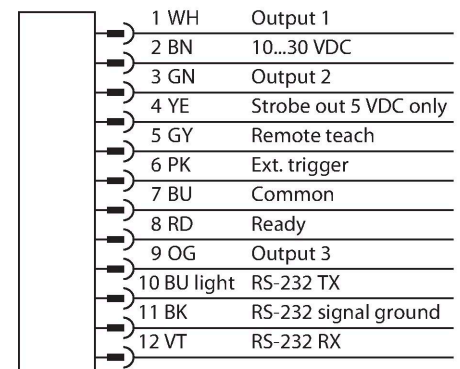

### Functional principle

The second generation of the iVu-Plus offers the user advanced features and even more options in the selection of the inspections. The sensor is equipped with the same housing and

offers the same intuitive user interface and functionality of the previous iVu generation. Sensor with 3 integrated operating modes:

1. Pattern recognition, checks if a pattern on a target is identical to the reference pattern.
2. Blob detection, for identification of one or more object features.
3. Feature detection with positioning, which adapts to the movements.

A blanking function for blob and feature detection is available in the new generation, so that areas in the field of view can be switched blind. Sensor configuration via PC is not required!  
Storage for 30 inspections.

## Mounting instructions

### Mounting instructions/Description

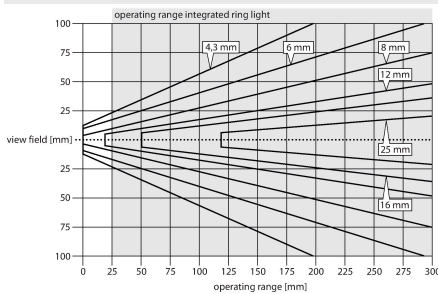

Selecting the focal length  
With known object size or scan field the matching vision sensor is found simply by determining the ratio between the sensing range and the focal length. Use the graphics for selection. Here, the sensing ranges are put in relation to the field view and the lens focal length.

## Accessories

### SMBIVURAR

3082547

Brackets for mounting on right side

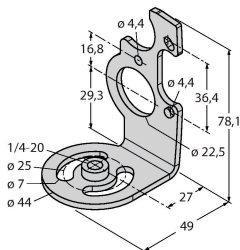

### SMBIVURAL

3082546

Brackets for mounting on left side



### SMBIVUU

3082549

U-bracket for base mounting (incl. SMBIVUB baseplate)

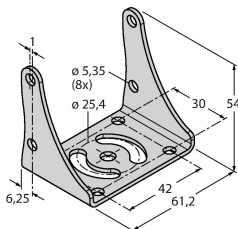

## Accessories

Dimension drawing	Type	ID	
	IVUC-1206	3014407	Power supply, M12 × 1 female connector, 12-pin, cable length: 1.83 m

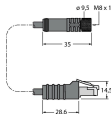
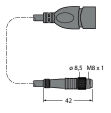
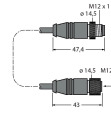
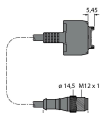

Dimension drawing	Type	ID	
	IVUC-E-406	3013892	Ethernet connection cable, M8 × 1 on RJ45, 4-pin, cable length: 2 m
	PSG-4M-401-USB	3011336	USB adapter cable, M8 × 1 male connector, 4-pin, cable length: 0.3 m
	IVURDM-QD-803	3028673	Extension cable for RDM35 remote display, M12 × 1, 8-pin, cable length: 0.91 m
	IVURD-MX-803	3011330	Extension cable for RD35 remote display, M12 × 1 to Molex, 8-pin, cable length: 0.91 m

## Accessories

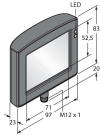
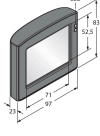
Dimension drawing	Type	ID	
	RDM35	3029512	Remote display 3.5" touch screen for device installation, connection via M12 plug connector, IVURDM-QD-8.. or IVURDM-QDK-8.. required
	RD35	3082646	Remote display 3.5", touch screen, connection via Molex integral connector, IVURD-MX-8.. or IVURD-MXK-8.. required