

TB-M30-H1147/C53

HF Read/Write Head – For Bus Line Topology with TBEN-*

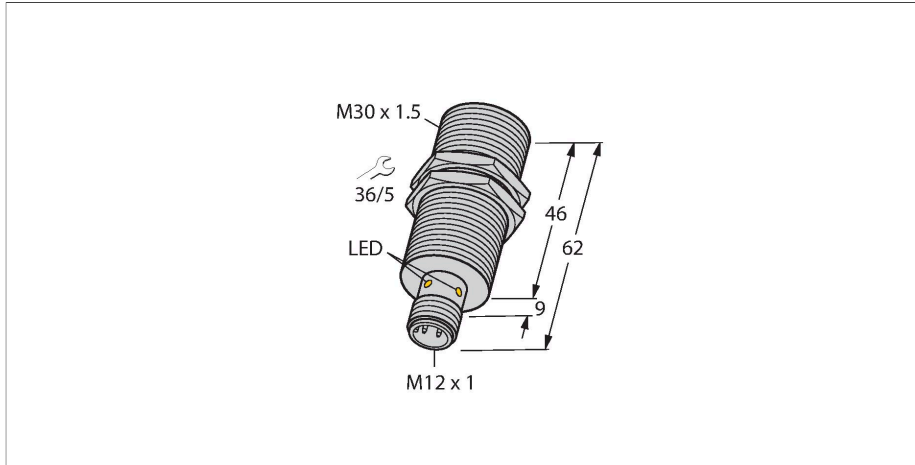

Technical data

Type	TB-M30-H1147/C53
ID	7030731
Approvals	CE UKCA UL
Radio approvals	EU/RED: Europe UK SI 2017/1206: United Kingdom FCC: USA MIC: Japan RCM: Australia/New Zealand
Electrical data	
Operating voltage	10...30 VDC
DC rated operational current	≤ 80 mA
inrush current	700 mA For: 1 ms
Data transfer	Inductive coupling
Technology	HF RFID
Operating frequency	13.56 MHz
Radio communication and protocol standards	ISO 15693 NFC Typ 5
Read/Write distance max.	45 mm
Output function	4-wire, Read/Write
Suitable for bus mode to TBEN-*	Yes
Mechanical data	
Mounting conditions	Flush
Ambient temperature	-25...+70 °C
Design	Threaded barrel, M30 x 1.5
Dimensions	62 mm
Housing diameter	Ø 30 mm
Housing material	Metal, CuZn, Chrome-plated
Active area material	Plastic, PA12-GF30

Features

- Threaded barrel, M30 x 1.5
- Chrome-plated brass
- Device without end termination
- Device may only be operated in line topology TBEN-S*-2RFID-* or TBEN-L*-4RFID-*
- Max. 32 nodes per line or connection permitted
- Use a corresponding terminating resistor (see accessories)
- Observe the performance of the power supply, especially when turned on, and the maximum current carrying capacity of the cables
- Observe the voltage drop on the line
- The maximum possible length of the spur line is 2 m
- The maximum possible length of the bus is 50 m
- By default, a command can only be processed by one read/write head, making HF bus mode suitable for static applications and slow dynamic applications
- In continuous HF bus mode, a command is executed simultaneously on all read/write heads in a bus topology. The recorded data is stored in the ring buffer of the module
- The read/write head is automatically assigned an address
- For different application requirements, the address and can be parameterized
- Powered and operated only via connection to BL ident interface module
- M12 × 1 connector, connection only via BL ident extension cable

.../S2503 Connectors

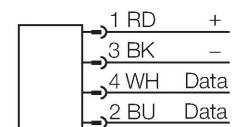

.../S2500 Connectors

Technical data

Vibration resistance	55 Hz (1 mm)
Shock resistance	30 g (11 ms)
Protection class	IP67
Electrical connection	M12 × 1
MTTF	391 years acc. to SN 29500 (Ed. 99) 20 °C
Power-on indication	LED, Green
Packaging unit	1

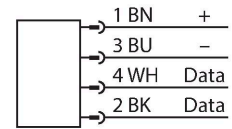

.../S2501 Connectors

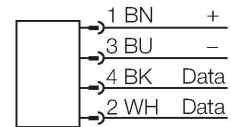

Functional principle

The HF read/write devices operating at a frequency of 13.56 MHz form a transmission zone, the size of which (0...500 mm) varies depending on the combination of read/write device and tag used.

The read/write distances mentioned here only represent standard values measured under laboratory conditions, free from any influences caused by surrounding materials.

The read/write distances of the tags for mounting in metal TW-R**-(MF) were determined in metal.

Attainable distances may vary by up to 30 % due to component tolerances, mounting conditions, ambient conditions and material qualities (especially when mounted in metal).

Testing of the application under real operating conditions is therefore essential, especially with on-the-fly reading and writing!

Mounting instructions/Description

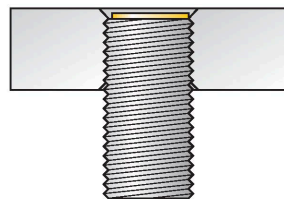

Diameter active Ø 30 mm
area B

flush mounting

LED	Color	Status	Meaning
1	OFF	OFF	Operating voltage switched off
	GREEN	ON	Operating voltage switched on
	GREEN	FLASHING (1 Hz)	HF field switched off
	GREEN	FLASHING (2 Hz)	Tag in detection range

Dimensions	Type designation	Read-write distance		Transfer zone		Minimum distance between two read-write heads [mm]
		Recommended (mm)	max. [mm]	length max. [mm]	width offset max. [mm]	
	Ident - no.					

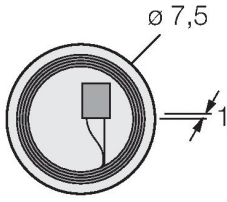
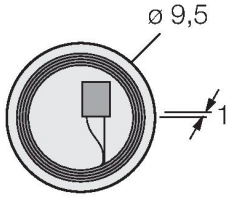
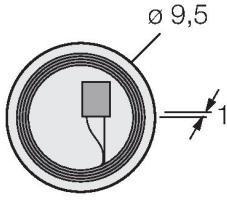
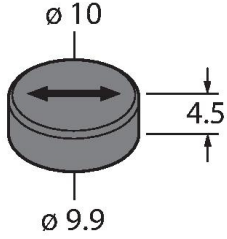
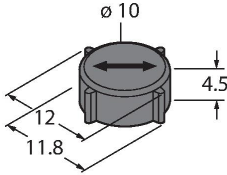
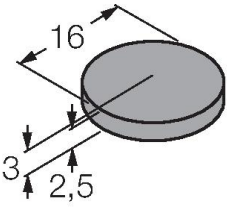
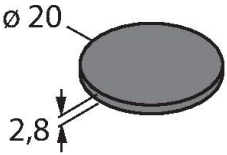
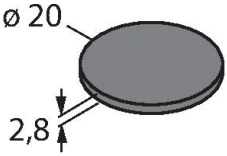
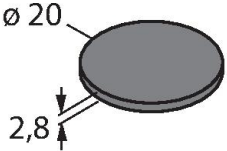
	TW-R7.5-B128 7030231	8	18	20	10	90
	TW-R9.5-B128 7030252	9	20	22	11	90
	TW-R9.5-K2 7030558	9	20	22	11	90
	TW-R10-M-B146 7030545	7	15	18	9	90
	TW-R12-M-B146 7030500	7	17	30	15	90
	TW-R16-B128 6900501	12	23	20	10	90
	TW-R20-B128 6900502	15	27	20	10	90
	TW-R20-B320 100005244	15	27	20	10	90
	TW-R20-K2 6900505	15	22	20	10	90

	TW-R30-B128 6900503	13	30	32	16	90
	TW-R30-B320 100005245	13	30	32	16	90
	TW-R30-K2 6900506	15	27	32	16	90
	TW-R50-B128 6900504	20	43	46	23	90
	TW-R50-B320 100005246	20	43	46	23	90
	TW-R50-K2 6900507	15	33	36	18	90
	TW-B510X1.5-19-K2 6901380	6	15	21	10	90
	TW-BD10X1.5-19-K2 6901381	10	20	22	11	90
	TW-SPP18X1-B128 6901062	10	17	26	13	90
	TW-R50-M-B128 7030209	15	27	22	11	90
	TW-R50-M-K2 7030229	10	21	26	13	90
	TW-R4-22-B128 7030237	5	16	22	11	90

	TW-L86-54-C-B128 6900479	20	45	80	40	90
	TW-L18-18-F-B128 7030634	16	29	16	8	90
	TW-BS8x1.25-19-K2 7030638	6	15	21	10	90

Accessories

BST-30B 6947216

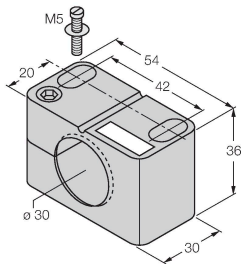

Mounting clamp for threaded barrel sensors, with dead-stop; material: PA6

BST-30N 6947217

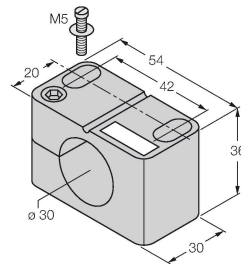

Mounting clamp for threaded barrel sensors, without dead-stop; material: PA6

QM-30 6945103

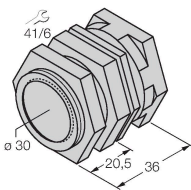

Quick-mount bracket with dead-stop; material: Chrome-plated brass. Male thread M36 × 1.5. Note: The switching distance of the proximity switches may change when using quick-mount brackets.

BSS-30 6901319

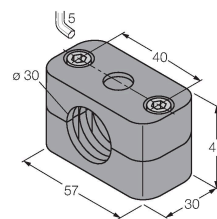

Mounting clamp for smooth and threaded barrel sensors; material: Polypropylene

BSS-TSM 2 pcs 6901323

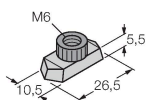

DIN rail nut for BSS and BSM mounting clips, for mounting on DIN rails

MW-30 6945005

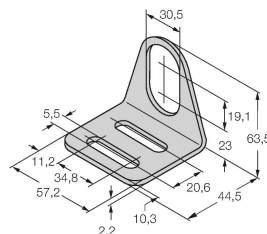

Mounting bracket for threaded barrel sensors; material: Stainless steel A2 1.4301 (AISI 304)

Accessories

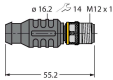
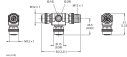
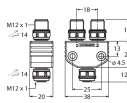
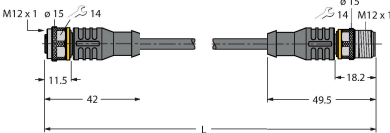
Dimension drawing	Type	ID	
	RSE57-TR2/RFID	6934908	Terminating resistor to build an RFID line topology
	VT2-FKM5-FKM5-FSM5	6930573	T-splitter to build an RFID line topology
	VB2-FKM5-FSM5.205-FSM5.305/S2550	6936821	Y-splitter for re-powering a supply voltage for the RFID bus topology
	RK4.5T-2-RS4.5T/S2503	7030331	BL ident cable, M12 female connector, straight to M12 male connector, cable length: 2 m, jacket material: PUR, black; other cable lengths and qualities available, see www.turck.com