

# QMT42VP6FF750Q

## Photoelectric Sensor – Diffuse Mode Sensor with Fixed-Field Background Suppression

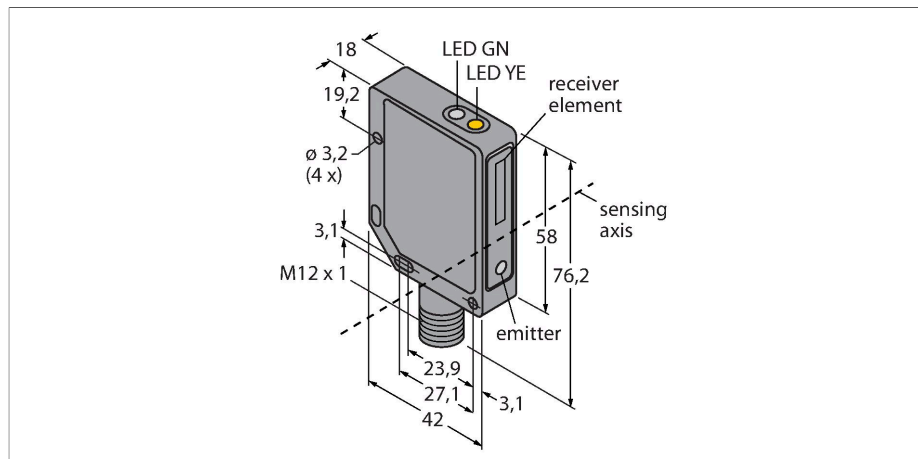

### Features

- Male M12 × 1, 4-pin
- Metal housing, ZN, black
- Protection class IP67
- Operating voltage 10...30 VDC
- PNP switching output
- Light/dark operation

### Wiring diagram

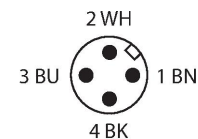
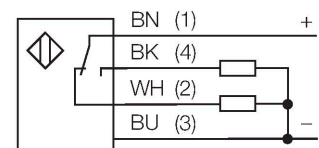

### Technical data

Type	QMT42VP6FF750Q
ID no.	3057371
<b>Optical data</b>	
Function	Proximity switch
Operating mode	Background suppression, non-adjustable
Light type	IR
Wavelength	880 nm
Range	50...750 mm
<b>Electrical data</b>	
Operating voltage	10...30 VDC
Residual ripple	< 10 % U <sub>ss</sub>
DC rated operational current	≤ 100 mA
No-load current	≤ 50 mA
Short-circuit protection	yes
Reverse polarity protection	yes
Output function	NO/NC, PNP
Switching frequency	≤ 500 Hz
Readiness delay	≤ 100 ms
Response time typical	< 1 ms
Overcurrent release	> 150 mA
<b>Mechanical data</b>	
Design	Rectangular, QMT42
Dimensions	42 x 18 x 76.2 mm
Housing material	Metal, Die-cast zinc alloy, Black-finished
Lens	plastic, Acrylic
Electrical connection	Connectors, M12 × 1, PVC

### Functional principle

Diffuse mode sensors with background suppression operate with a single emitter and several receiver elements. The target position and the photoelectric structure of the sensor determine which of the receiving elements receives the most light. The sensor electronics determine whether the reflecting object is within or outside the measuring range. These sensors come with a fixed cut-off point.

Excess gain curve  
Excess gain in relation to the distance

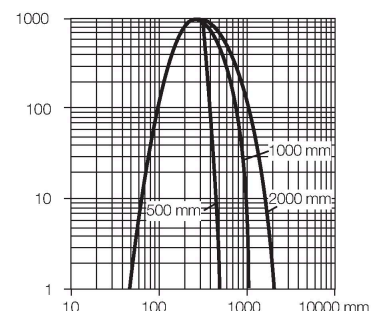

## Technical data

Number of cores	4
Ambient temperature	-20...+55 °C
Protection class	IP67
Power-on indication	LED, Green
Switching state	LED, Yellow
Error indication	LED, green, Flashing
Excess gain indication	LED
Alarm display	LED yellow Flashing
<b>Tests/approvals</b>	
Approvals	CE, cURus

## Accessories

SMB30SK

3052523

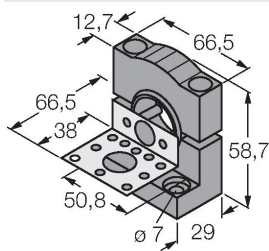

Mounting bracket, PBT black, with mounting plate, stainless steel, for types with 18 mm thread, QM42/ QMT42

SMB46S

3048748

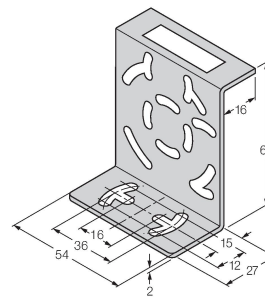

Mounting bracket, stainless steel, for QS18, QS30, MINI-BEAM, QM42/ QMT42

SMB46L

3048747

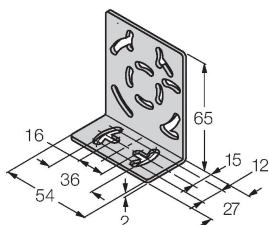

Mounting bracket, stainless steel, for QS18, QS30, MINI-BEAM, QM42/ QMT42