

# WKCV4.5T-5/TEL

## Actuator and Sensor Cable, PVC – Connection Cable

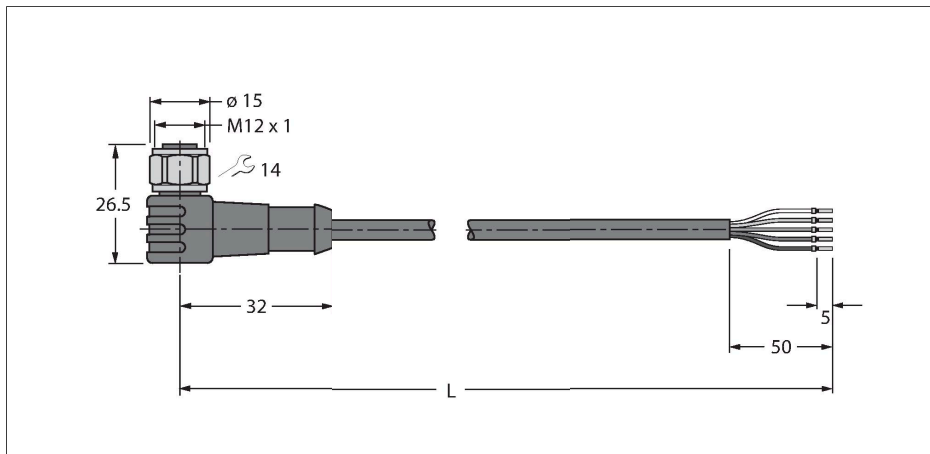

### Features



- Female M12, angled, 5-pin
- Coupling nut/screw, stainless steel
- Jacket material: PVC
- Jacket color: black
- Resistant to chemicals and oils
- Flame retardant
- Resistant to acids and alkaline solutions
- Resistant to microbes and hydrolysis
- LABS free
- Protection class: IP67, IP69K
- Cable length: 5.0 m

### Cable Cross-Section

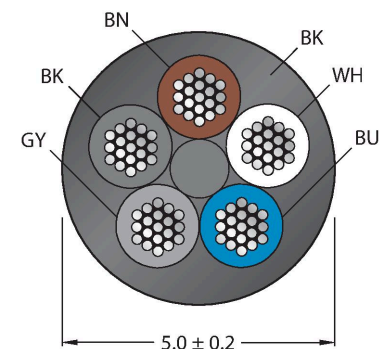

### Contact assignment

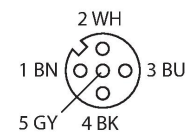

### Circuit Diagram



### Technical data

Type	WKCV4.5T-5/TEL
ID	6626253
Connector A	Female, M12 × 1, Angled, A-coded
Number of Pins	5
Contacts	Brass, CuZn, Gold-plated
Contact carriers	Plastic, TPU, Black
Connector body	Plastic, TPU, Black
Coupling nut/screw	Stainless Steel, V4A
Seal	Plastic, FPM/FKM
Mechanical lifespan	> 100 Mating cycles
Pollution degree	3
Protection class	IP67, IP69K, Only in screwed condition
Cable	
Cable diameter	Ø 5 mm ±0.20
Cable length	5 m
Cable jacket	PVC, Black
Core insulation	PVC
Core cross-section	5 x 0.34 mm <sup>2</sup>
Arrangement of strands	42 x 0.1 mm
Core colors	BN, WH, BU, BK, GY
Electrical properties at +20 °C	
Rated voltage	60 V
Test voltage	2000 V
Current	4 A
Insulation resistance	> 30.5 MΩ/km
forward resistance	max. 57 Ω/km

**Technical data**

**Mechanical and chemical properties**

Bending radius (stationary installation)	≥ 5 x Ø
Bending radius (flexible use)	≥ 10 x Ø
Ambient temperature range (stationary)	-40...+105 °C
Ambient temperature range (In motion)	-5...+80 °C
Approvals	cULus

**Accessories**

FW-ERSPM0526-SA-P-0408

100002535

Field-wireable male connector, M12 × 1, straight, 5-pin, push-in connection, cable feedthrough 4.0 to 8.0 mm, core cross-section/terminal capacity 0.14 to 0.75 mm<sup>2</sup>, plastic housing, metal retaining screw

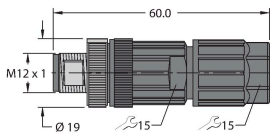

FW-ERSPM0516-SA-S-0408

100002289

Field-wireable male connector, M12 × 1, straight, 5-pin, screw terminal connection, cable feedthrough 4.0 to 8.0 mm, core cross-section/terminal capacity 0.25 to 1.5 mm<sup>2</sup>, plastic housing, metal retaining screw

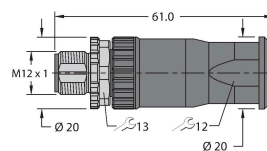

FW-EWSPM0516-SA-S-0408

100002291

Field-wireable male connector, M12 × 1, angled, 5-pin, screw terminal connection, cable feedthrough 4.0 to 8.0 mm, core cross-section/terminal capacity 0.25 to 1.5 mm<sup>2</sup>, plastic housing, metal retaining screw

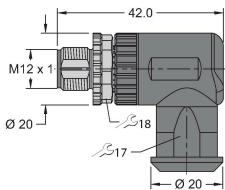

TORQUE-WRENCH-SET-AS

6936170

Torque wrench set; handles with adjustable torque 0.4-1.0 Nm, torque wrench for M8 (SW9), fork wrench for M12 (SW 14)

BLANK-LABEL-FOR-CORDSETS-TEL-TXL

6936206

Label for TEL and TXL cables, length: 18 mm, height: 4 mm, material: polycarbonate (PC), color: white, halogen-free and flame-retardant

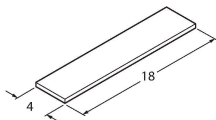

**Accessories**

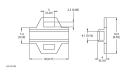
Dimension drawing	Type	ID	
	LABEL-HOLDER-FLEX-PVC	100048170	PVC label holder for identification of extension cables (TEL/TXL product series); for cable diameters: min. 5 mm; dimensions 4 × 18 mm; delivery unit: 50 pcs. per package