

# REI-E-114I10T-2B2500-H1181

## Incremental Encoder

### Efficiency Line

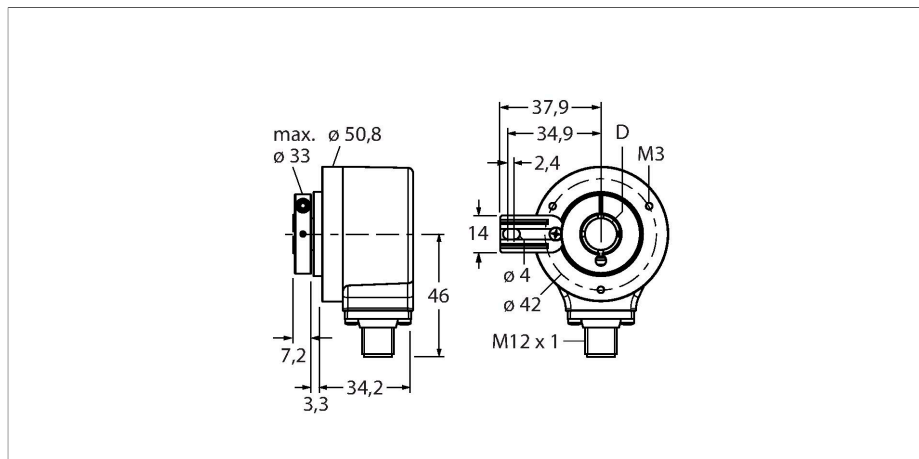

#### Technical data

Type	REI-E-114I10T-2B2500-H1181
ID	100011677
Measuring principle	Optical
<b>General data</b>	
Max. Rotational Speed	4500 rpm
Moment of inertia of the rotor	$6 \times 10^{-6} \text{ kgm}^2$
Starting torque	< 0.05 Nm
Output type	Incremental
Resolution, incremental	2500 ppr
<b>Electrical data</b>	
Operating voltage	10...30 VDC
No-load current	100 mA
Output current	$\leq 30 \text{ mA}$
Short-circuit protection	yes
Wire breakage/Reverse polarity protection	yes
Pulse frequency max.	300 kHz
Signal level high	min. $U_B - 1 \text{ V}$
Signal level low	max. 0.5 V
Output function	Push-Pull/HTL, invertable
<b>Mechanical data</b>	
Design	Hollow shaft
Flange type	Flange with mounting element
Flange diameter	$\text{Ø } 50.8 \text{ mm}$
Shaft Type	Hollow shaft
Shaft diameter D [mm]	10

#### Features

- Flange with torque stop
- Hollow shaft,  $\text{Ø } 10 \text{ mm}$
- Optical measuring principle
- Shaft material: stainless steel
- Protection class IP64 on housing and shaft side
- $-20 \dots +70 \text{ °C}$
- Max. 4500 rpm (continuous operation 3000 rpm)
- 10...30 VDC
- Push-pull/HTL invertible
- Pulse frequency max. 300 kHz
- M12 x 1 male connector, 8-pin
- 2500 pulses per revolution

#### Wiring diagram

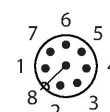
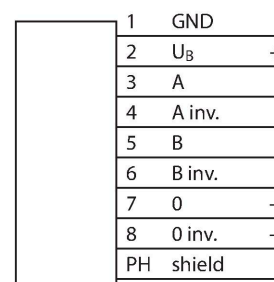

## Technical data

Shaft material	Stainless steel
Housing material	Die-cast zinc
Electrical connection	Connector, M12 × 1
	8-pin
Axial shaft load	40 N
Radial shaft load	80 N
<b>Environmental conditions</b>	
Ambient temperature	-20...+70 °C
Vibration resistance (EN 60068-2-6)	100 m/s <sup>2</sup> , 10...2000 Hz
Shock resistance (EN 60068-2-27)	1000 m/s <sup>2</sup> , 6 ms
Protection class	IP64
Protection class shaft	IP64

## Accessories

RME-1

1544612

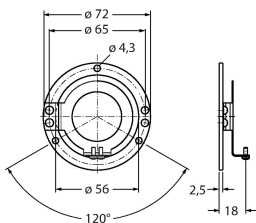

Stainless steel stator coupling for hollow shaft encoders, reference diameter, 65 mm, for highly dynamic, standard applications with axial and radial play

RME-2

1544613

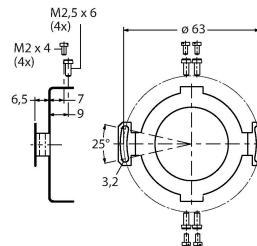

Stainless steel stator coupling for hollow shaft encoders, reference diameter 63 mm, for applications with high demands on accuracy

RME-4

1544615

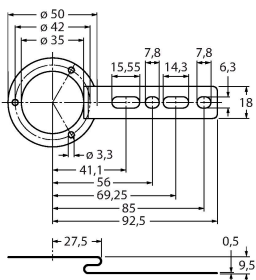

Stainless steel mounting panel for hollow shaft encoders, reference diameter 80...170 mm, for low dynamic applications with axial and radial play

RME-7

1544618

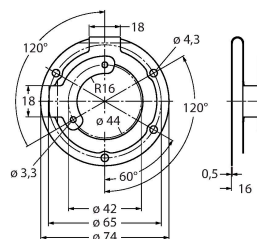

Stainless steel stator coupling for hollow shaft encoders, reference diameter 65 mm, for highly dynamic applications with axial and radial play

RME-8

1544619

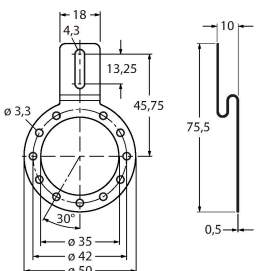

Stainless steel mounting panel for hollow shaft encoders, reference diameter 65...91.5 mm, for applications with axial and radial play at constant rotation speed

RME-9

1544620

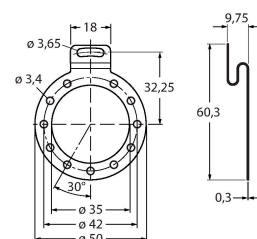

Stainless steel mounting panel for hollow shaft encoders, reference diameter 64.5 mm, for low dynamic applications with axial and radial play

RME-13

1544624

Plastic mounting element for hollow shaft encoders, pitch diameter 42 mm, for applications with limited axial play, low dynamics and limited mounting space

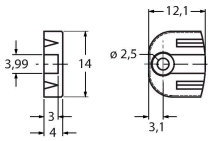

RME-14

1544625

Plastic mounting element for hollow shaft encoders, pitch diameters 44 mm, 60 mm, 63 mm, 65 mm, for low dynamic applications with high axial play.

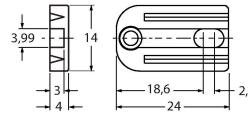

## Accessories

Dimension drawing	Type	ID	
	RKC8T-2/TXL	6625142	Connection cable, M12 female connector, straight, 8-pin, cable length: 2 m, jacket material: PUR, black; cULus approval
	WKC8T-2/TXL	6625145	Connection cable, M12 female connector, angled, 8-pin, cable length: 2 m, jacket material: PUR, black; cULus approval