

WKH4.4-P7X2-1-WKH4.4-P7X2/TFE

Food & Beverage Hygienic, PVC – Extension Cable

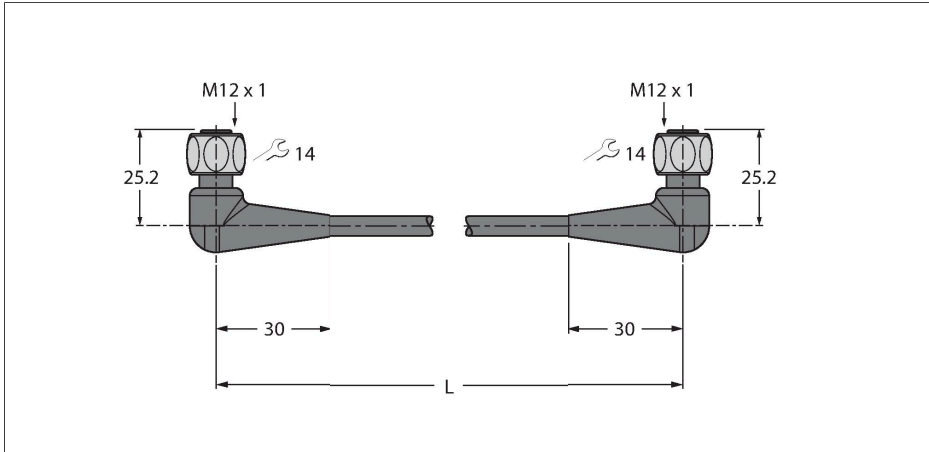

Features



- M12 female connector, angled, 4-pin
- With 2-color LED (PNP, yellow, green)
- Stainless steel coupling nut/screw
- M12 female, angled, 4-pin
- Jacket material: PVC
- Jacket color: gray RAL 7040
- Resistant to acids and alkalis
- Resistant to oils and chemicals
- Flame-retardant acc. to DIN EN 60332 1-2, DIN EN 60332 2-2, VDE 0482 332-1-2, VDE 0482 332-2-2
- Approvals: Gost, Ecolab
- RoHS and REACH compliant
- Protection class IP67/IP69K
- Cable length: 1.0 m

Technical data

Type	WKH4.4-P7X2-1-WKH4.4-P7X2/TFE
ID	100000178
Connector A	Female, M12 × 1, Angled
Number of Pins	4
Contacts	Brass, CuZn, Gold-plated
Contact carriers	Plastic, PP, Gray
Connector body	Plastic, PP, Transparent
Coupling nut/screw	Stainless Steel, V4A
Seal	Plastic, FPM/FKM
Tightening torque (range)	0.8 ... 1 Nm (observe max. torque of mating connector!)
LED display	dual LED
Display operating voltage	LED, Green
Display switch state	LED, Yellow
Mechanical lifespan	> 100 Mating cycles
Pollution degree	3
Protection class	IP67, IP69K, Only in screwed condition
Connector B	Female, M12 × 1, Angled
Number of pins	4
Contacts	Brass, CuZn, Gold-plated
Contact carriers	Plastic, PP, Gray
Connector body	Plastic, PP, Transparent
Coupling nut/retaining screw	Stainless Steel, V4A
Seal	Plastic, FPM/FKM
Operating voltage	LED, Green
Display switch state	LED, Yellow
Mechanical life	> 100 Mating cycles

Cable Cross-Section

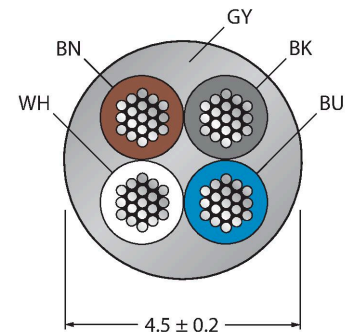

Contact assignment



Circuit Diagram

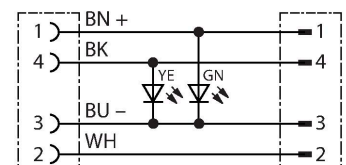

Technical data

Pollution degree	3
Protection class	IP67, Only when screwed together
Cable	
Cable diameter	Ø 4.5 mm ±0.20
Cable length	1 m
Cable jacket	PVC, Gray
Core insulation	PVC
Core cross-section	4 x 0.34 mm ²
Arrangement of strands	19 x 0.15 mm
Core colors	BN, WH, BU, BK
Electrical properties at +20 °C	
Rated voltage	30 V
Test voltage	1500 V
Current	4 A
Insulation resistance	≥ 10 ⁸ Ω
Mechanical and chemical properties	
Bending radius (stationary installation)	≥ 3 x Ø
Bending radius (flexible use)	≥ 10 x Ø
Ambient temperature range (stationary)	-25...+80 °C
Ambient temperature range (In motion)	0...+80 °C

Accessories

TORQUE-WRENCH-SET-AS	6936170
Torque wrench set; handles with adjustable torque 0.4-1.0 Nm, torque wrench for M8 (SW9), fork wrench for M12 (SW 14)	