

PS016V-503-2UPN8X-H1141/3GD

Pressure Transmitter (Rotatable) – 2 PNP/NPN Transistor Switching Outputs

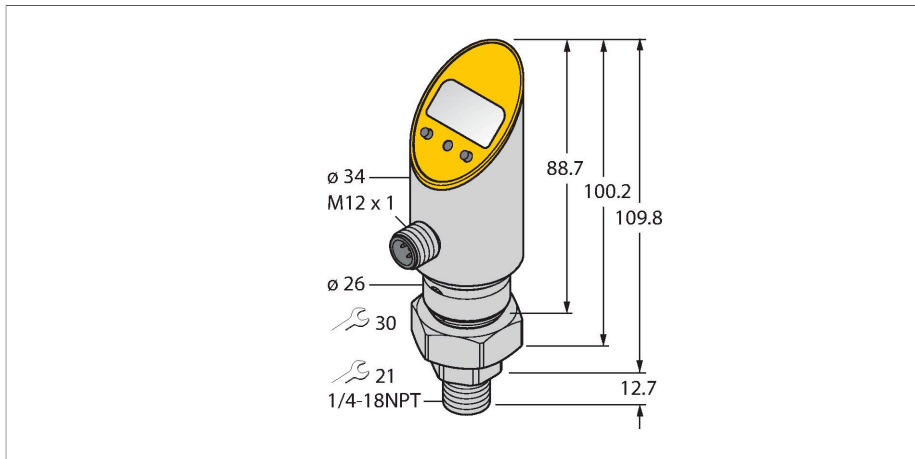

Features

- Housing is rotatable after plugging the process connection
- Reading of adjusted values without tool
- Recessed pushbutton and keylock for secure programming
- Permanent indication of pressure (bar, psi, kPa, MPa, misc)
- Peak pressure memory
- Pressure range -1...16 bar rel.
- ATEX category II 3 G, Ex zone 2
- ATEX category II 3 D, Ex zone 22

Wiring diagram

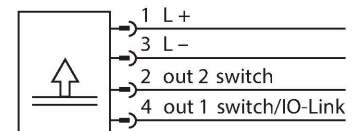

Functional principle

The pressure sensors in the PS product series operate with ceramic measuring cells. As a result of the pressure acting on the ceramic substrate, a signal that is proportional to the pressure is generated and processed electronically. The processed signal is available either as a switching or an analog output signal, depending on the sensor type used. Maximum flexibility thanks to a rigid or rotatable sensor body, a variety of thread types, front-flush or dead-space-free pressure membranes and an accuracy of 0.5 % of full scale guarantee a safe connection to the process.

Technical data

Type	PS016V-503-2UPN8X-H1141/3GD
ID	6833959
Pressure range	
Pressure type	Relative pressure
Pressure range	-1...16 bar
	-14.5...232.06 psi
	-0.1...1.6 MPa
Admissible overpressure	≤ 40 bar
Burst pressure	≥ 40 bar
Response time	< 3 ms
Power supply	
Operating voltage	18...30 VDC
Current consumption	≤ 50 mA
Voltage drop at I _o	≤ 2 V
Protective measure	SELV; PELV according to EN 50178
Short-circuit/reverse polarity protection	yes / yes
Protection type and class	IP67 IP69K / III
Outputs	
Output 1	Switching output or IO-Link mode
Output 2	Switching output
Switching output	
Communication protocol	IO-Link
Output function	NO/NC, PNP/NPN
Accuracy	± 0.5 % FS BSL

Technical data

Rated operational current	0.2 A
Switching frequency	≤ 180 Hz
Switching point distance	≥ 0.5 %
Switch point:	(Min. + 0.005 × range)...100 % of full scale
Release point(s)	min up to (SP - 0.005 x range)
Switching cycles	≥ 100 mil.
IO-Link	
IO-Link specification	V 1.0
Programming	FDT / DTM
Transmission physics	corresponds to 3-wire physics (PHY2)
Transmission rate	COM 2 / 38.4 kbps
Process data width	16 bit
Measured value information	14 bit
Switchpoint information	2 bit
Frame type	2.2
Accuracy	± 0.5 % FS BSL
Included in the SIDI GSDML	Yes
Temperature behaviour	
Medium temperature	-40...+85 °C
Temperature coefficient zero point TK ₀	± 0.15 % of full scale/10 K
Temperature coefficient range TK _s	± 0.15 % of full scale/10 K
Environmental conditions	
Ambient temperature	-40...+70 °C
Storage temperature	-40...+80 °C
Vibration resistance	20 g (9...2000 Hz), according to IEC 68-2-6
Shock resistance	50 g (11 ms) acc. to IEC 68-2-27
EMV	EN 61000-4-2 ESD:4 kV CD / 8 kV AD EN 61000-4-3 HF radiated: 15 V/m EN 61000-4-4 Burst: 2 kV EN 61000-4-5 Surge: 1000 V, 42 Ohm EN 61000-4-6 HF cable bound: 10 V
Mechanical data	
Housing material	Stainless-steel/Plastic, 1.4305 (AISI 303)
Pressure connection material	Stainless steel 1.4305 (AISI 303)
Pressure transducer material	Ceramic Al ₂ O ₃
Sealing material	FPM spez.
Process connection	1/4" NPT-18 male thread
Wrench size pressure connection / coupling nut	21/ 30
Electrical connection	Connector, M12 × 1
Max. tightening torque of housing nut	35 Nm

Technical data

Reference conditions acc. to IEC 61298-1	
Temperature	15...+25 °C
Atmospheric pressure	860...1060 hPa abs.
Humidity	45...75 % rel.
Auxiliary power	24 VDC
Display	4-digit 7-segment display, rotatable by 180°, with switch-off function
Switching state	2 × LEDs, Yellow
Unit display	5 x LEDs green (bar, psi, kPa, MPa, misc)
Programming options	switch/release point, PNP/NPN; NO/NC; hysteresis/window mode, muting; pressure unit, peak pressure memory
Tests/approvals	
Approvals	cULus
UL registration number	E183243
MTTF	439 years acc. to SN 29500 (Ed. 99) 40 °C
Included in delivery	SC-M12/3GD

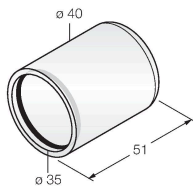

Accessories

PTS-COVER	A9350
Protective housing	

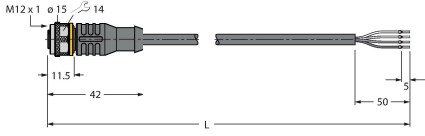
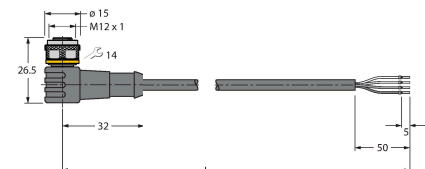

Accessories

Dimension drawing	Type	ID	
	WKC4.4T-2/TEL	6625025	Connection cable, M12 female connector, angled, 4-pin, cable length: 2 m, jacket material: PVC, black; cULus approval

Dimension drawing	Type	ID	
 <p>Technical drawing of the RKC4.4T-2/TEL cable. It shows an M12 female connector with a diameter of 15mm and a length of 11.5mm. The cable length is 42mm. The terminal block has a length of 50mm and a diameter of 14mm. The total length is labeled as L.</p>	RKC4.4T-2/TEL	6625013	Connection cable, M12 female connector, straight, 4-pin, cable length: 2 m, jacket material: PVC, black; cULus approval
 <p>Technical drawing of the RKC4.4T-2/TXL cable. It shows an M12 female connector with a diameter of 15mm and a length of 11.5mm. The cable length is 42mm. The terminal block has a length of 50mm and a diameter of 14mm. The total length is labeled as L.</p>	RKC4.4T-2/TXL	6625503	Connection cable, M12 female connector, straight, 4-pin, cable length: 2 m, jacket material: PUR, black; cULus approval
 <p>Technical drawing of the WKC4.4T-2/TXL cable. It shows an angled M12 female connector with a diameter of 15mm and a length of 26.5mm. The cable length is 32mm. The terminal block has a length of 50mm and a diameter of 14mm. The total length is labeled as L.</p>	WKC4.4T-2/TXL	6625515	Connection cable, M12 female connector, angled, 4-pin, cable length: 2 m, jacket material: PUR, black; cULus approval
 <p>Technical drawing of the RKC4.4T-P7X2-10/TXL cable. It shows an M12 female connector with a diameter of 15mm and a length of 11.5mm. The cable length is 48.5mm. The terminal block has a length of 50mm and a diameter of 16.2mm. The total length is labeled as L.</p>	RKC4.4T-P7X2-10/TXL	6626184	Connection cable, M12 female connector, straight, 4-pin, LED, cable length: 10 m, jacket material: PUR, black; cULus approval

Accessories

Dimension drawing	Type	ID	
 <p>Technical drawing of the USB-2-IOL-0002 IO-Link Master. It is a rectangular device with dimensions 41mm (width) x 54mm (depth) x 24mm (height). It features an M12 x 1 connector on the front. Labels indicate: LED: CH1 (C/Q), LED: CH2 (DI/DO), Error, USB-Mini, LED: PWR, and IN-DC.</p>	USB-2-IOL-0002	6825482	IO-Link Master with integrated USB port

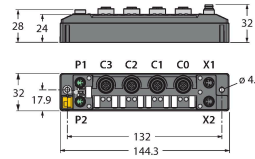
Dimension drawing	Type	ID	
 <p>The drawing shows two views of the TBEN-S2-4IOL module. The top view shows a rectangular module with a width of 28 mm and a depth of 24 mm. The front view shows a total length of 144.3 mm and a height of 32 mm. The front view also shows terminal positions: P1, C3, C2, C1, C0, X1, P2, and X2. A diameter of 4.6 mm is indicated for one of the terminals.</p>	TBEN-S2-4IOL	6814024	Compact multiprotocol I/O module, 4 IO-Link Master 1.1 Class A, 4 universal PNP digital channels 0.5 A

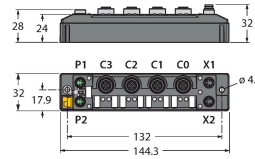

Instructions for use

Intended use

This device fulfills the directive 2014/34/EC and is suited for use in explosion hazardous areas acc. to EN60079-0:2012, EN60079-15:2010 and EN60079-31:2009. In order to ensure correct operation to the intended purpose it is required to observe the national regulations and directives.

For use in explosion hazardous areas conform to classification

II 3 G and II 3 D (Group II, Category 3 G, electrical equipment for gaseous atmospheres and category 3 D, electrical equipment for dust atmospheres).

Marking (see device or technical data sheet)

Ⓔ II 3 G Ex nA IIC T5 Gc acc. to EN 60079-0:2012 and EN 60079-15:2010 and Ⓔ II 3 D Ex tc IIIC T90°C Dc acc. to EN 60079-0:2012 and EN 60079-31:2009

Local admissible ambient temperature

0...+60 °C

Installation/Commissioning

These devices may only be installed, connected and operated by trained and qualified staff. Qualified staff must have knowledge of protection classes, directives and regulations concerning electrical equipment designed for use in explosion hazardous areas. Please verify that the classification and the marking on the device comply with the actual application conditions.

Installation and mounting instructions

Avoid static charging of cables and plastic devices. Please only clean the device with a damp cloth. Do not install the device in a dust flow and avoid build-up of dust deposits on the device. The devices must be protected against strong magnetic fields. The pin configuration and the electrical specifications can be taken from the device marking or the technical data sheet. In order to avoid contamination of the device, please remove possible blanking plugs of the cable glands or connectors only shortly before inserting the cable or opening the cable socket.

Special conditions for safe operation

Do not disconnect the plug-in connection or cable under voltage. Please attach a warning label permanently in an appropriate fashion in close proximity to the plug-in connection with the following inscription: Nicht unter Spannung trennen / Do not separate when energized. The device must be protected against mechanical damage caused by energy > 4 Joule and harmful UV rays. The IP protection rating of the connectors is given only in combination with a suitable O-ring. Load voltage and operating voltage of this equipment must be supplied from power supplies with safe isolation (IEC 60 364/UL508), to ensure that the rated voltage of the equipment (24 VDC +20% = 28.8 VDC) is never exceeded by more than 40%.

Service/Maintenance

Repairs are not possible. The approval expires if the device is repaired or modified by a person other than the manufacturer. The most important data from the approval are listed.