

M12PFF25 W/30

Photoelectric Sensor – Diffuse Mode Sensor with Fixed-Field Background Suppression

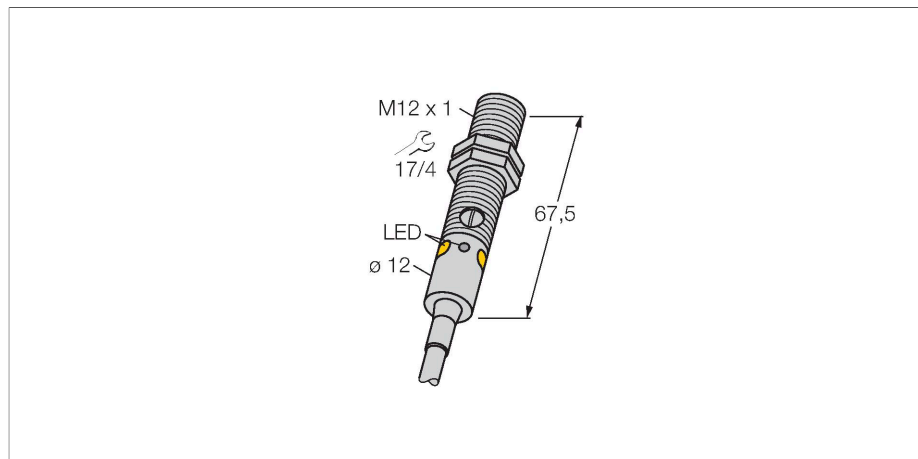

Features

- Cable, PVC, 9 m, 4-wire
- Protection classes IP67 / IP68
- Metal housing
- LED all-round visible
- Indication of insufficient excess gain
- Operating voltage: 10...30 VDC
- PNP switching output, complementary contact

Wiring diagram

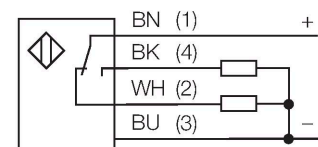

Technical data

Type	M12PFF25 W/30
ID no.	3077212
Optical data	
Function	Proximity switch
Operating mode	Background suppression, non-adjustable
Light type	Red
Wavelength	680 nm
Range	0...25 mm
Electrical data	
Operating voltage	10...30 VDC
Residual ripple	< 10 % U _{ss}
DC rated operational current	≤ 100 mA
No-load current	≤ 20 mA
Short-circuit protection	yes
Reverse polarity protection	yes
Output function	Complementary contact, PNP
Switching frequency	≤ 1000 Hz
Readiness delay	≤ 100 ms
Response time typical	< 0.5 ms
Mechanical data	
Design	Threaded barrel, M12
Dimensions	Ø 12 x 67.5 mm
Housing material	Metal, Nickel-plated brass, Nickel-plated
Lens	plastic, PMMA
Electrical connection	Cable, 9 m, PVC
Number of cores	4

Functional principle

Diffuse mode sensors with background suppression operate with a single emitter and several receiver elements. The target position and the photoelectric structure of the sensor determine which of the receiving elements receives the most light. The sensor electronics determine whether the reflecting object is within or outside the measuring range. These sensors come with a fixed cut-off point.

Excess Gain Curve

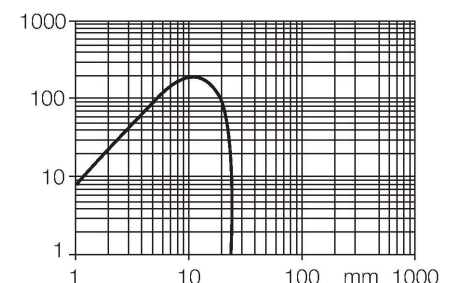

Technical data

Core cross-section	0.35 mm ²
Ambient temperature	-20...+60 °C
Protection class	IP67 IP68
Special features	Encapsulated Wash down
Power-on indication	LED, Green
Switching state	LED, Yellow
Error indication	LED, green, Flashing
Excess gain indication	LED, yellow, flashing
Tests/approvals	
MTTF	46 years acc. to SN 29500 (Ed. 99) 40 °C
Approvals	CE

Accessories

SMB12FAM10

3011221

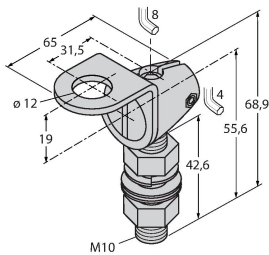

Mounting bracket, stainless steel, for M12, M10 x 1.5 thread

SMB12MM

3027635

Mounting bracket, stainless steel, for M12

SMBQS12PD

3059606

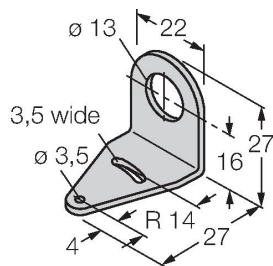

Mounting bracket; material VA 1.4401, for Q12 & M12 series