

Q20PLP

Photoelectric Sensor – Retroreflective Sensor with Polarizing Filter

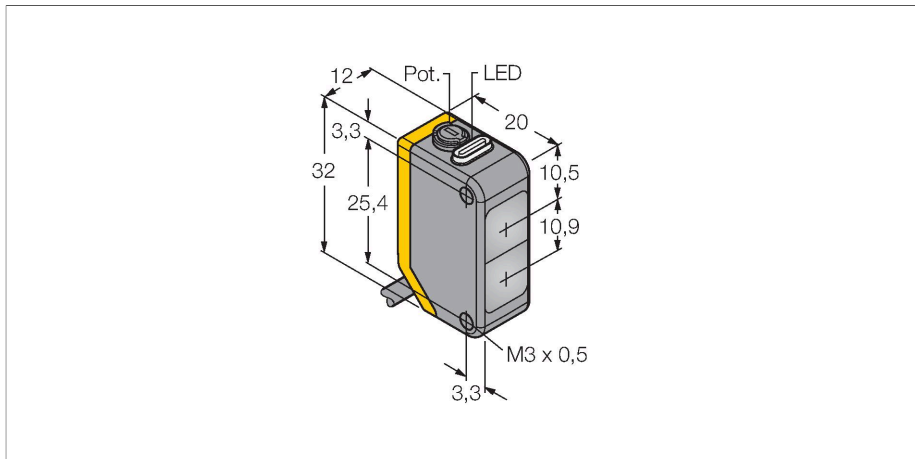

Technical data

Type	Q20PLP
ID no.	3077761
Optical data	
Function	Retroreflective Sensor
Operating mode	Polarized
Reflector included in delivery	no
Light type	Red polarized
Wavelength	645 nm
Range	30...4000 mm
Electrical data	
Operating voltage	10...30 VDC
Residual ripple	< 10 % U _{ss}
DC rated operational current	≤ 100 mA
No-load current	≤ 18 mA
Reverse polarity protection	yes
Output function	Complementary contact, PNP
Switching frequency	≤ 600 Hz
Readiness delay	≤ 100 ms
Response time typical	< 0.8 ms
Setting option	Potentiometer
Mechanical data	
Design	Rectangular, Q20
Dimensions	20 x 12 x 32 mm
Housing material	Plastic, Thermoplastic material
Lens	plastic, Acrylic
Electrical connection	Cable, 2 m, PVC

Features

- Cable, PVC, 2 m
- Protection class IP67
- LED all-round visible
- Sensitivity adjusted via potentiometer
- Operating voltage: 10...30 VDC
- PNP switching output, changeover

Wiring diagram

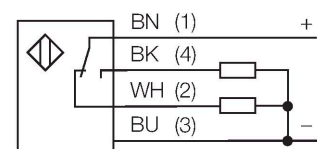

Functional principle

Retro-reflective sensors incorporate emitter and receiver in the same compact housing. The light beam of the emitter is directed towards a reflector which returns the light back to the receiver. An object is detected when it interrupts this beam. Retro-reflective sensors incorporate some of the advantages of opposed mode sensors (good contrast and high excess gain). Further it is merely required to install and wire a single device. A smaller sensing range and susceptibility of devices without polarisation filter can be of disadvantage when shiny objects have to be detected.

Excess gain curve
Excess gain in relation to the distance (type LP)

Technical data

Number of cores	4
Core cross-section	0.35 mm ²
Ambient temperature	-20...+60 °C
Protection class	IP67
Power-on indication	LED, Green
Switching state	LED, Yellow
Error indication	LED, green, Flashing
Excess gain indication	LED, yellow, flashing
Tests/approvals	
Approvals	CE

Excess Gain Curve

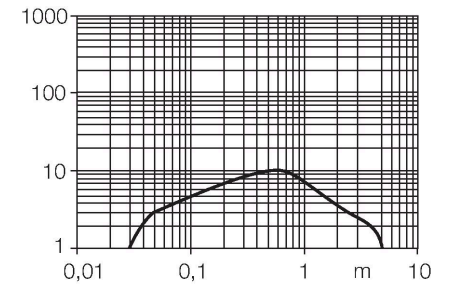

Accessories

SMBQ20H

3079041

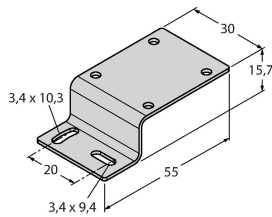

Mounting bracket, stainless steel, horizontally mounted, for Q20

SMBQ20L

3079040

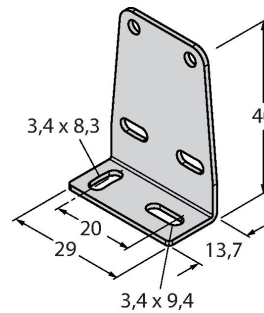

Mounting bracket, stainless steel, rectangular, for Q20

SMBQ20LV

3079042

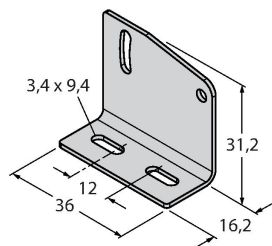

Mounting bracket, stainless steel, rectangular, for Q20

SMBQ20U

3079043

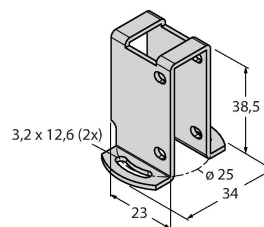

Protective housing, stainless steel, for Q20

Accessories

Dimension drawing	Type	ID no.	
	BRT-84	3058979	Round reflector, reflection coefficient 1.4, material acrylic, ambient temperature -20 ... +60 °C

