

RKSV4.4T-5/TFW

Actuator And Sensor Cable, PP-EPDM – Connection Cable

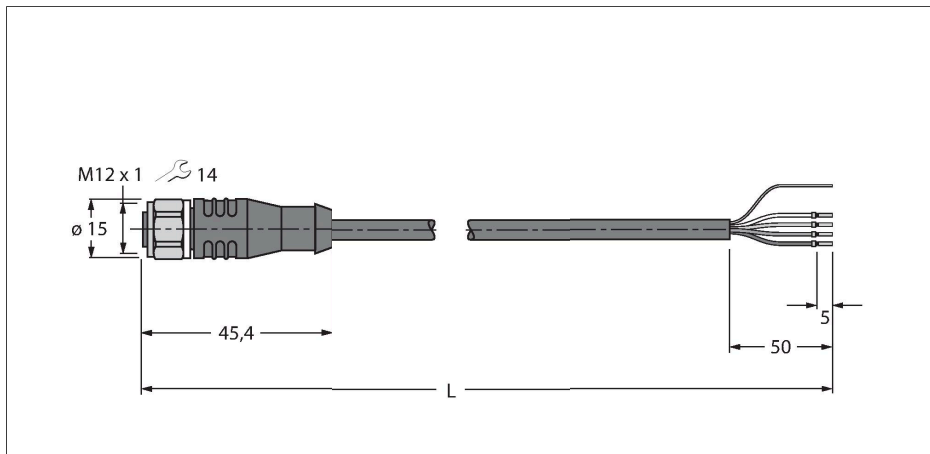

Features



- M12 female connector, straight, 4-pin
- Stainless steel coupling nut/screw
- Sheath material: PP-EPDM, shielded
- Sheath color: white
- Resistant to acids and alkaline solutions
- Resistant to detergents and disinfectants
- Resistant to hydrolysis acc. to DIN EN 60068-2-78
- Free from silicone and PVC
- Halogen-free acc. to DIN EN 50267-2-1, IEC 60754-1, VDE 0482-267-2-1
- Approvals: Ecolab, FDA
- RoHS and REACH compliant
- Protection classes IP67, IP69K
- Cable length: 5.0 m

Technical data

Type	RKSV4.4T-5/TFW
ID	6934811
Connector A	Female, M12 × 1, Straight
Number of Pins	4
Contacts	Brass, CuZn, Gold-plated
Contact carriers	Plastic, PP, White
Connector body	Plastic, PP, White
Coupling nut/screw	Stainless Steel, V4A
Seal	Plastic, FPM/FKM
Tightening torque (range)	0.8 ... 1 Nm (observe max. torque of mating connector!)
Mechanical lifespan	> 100 Mating cycles
Pollution degree	3
Protection class	IP67, IP69K, Only in screwed condition
Cable	
Cable diameter	Ø 4.7 mm ±0.20
Cable length	5 m
Cable jacket	PP-EPDM, White
Shielding	Aluminum/Polyester foil
Core insulation	PE
Core cross-section	4 x 0.34 mm ²
Arrangement of strands	42 x 0.1 mm
Core colors	BN, WH, BU, BK
Electrical properties at +20 °C	
Rated voltage	250 V
Test voltage	500 V
Current	4 A

Cable Cross-Section

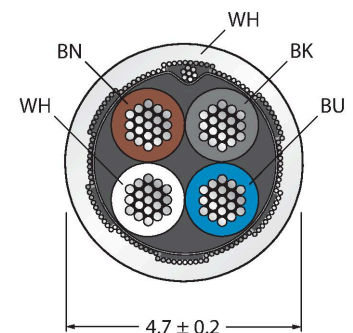

Contact assignment

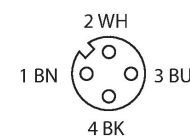

Circuit Diagram

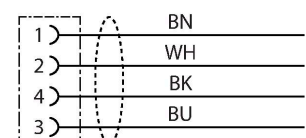

Technical data

forward resistance max. 57 Ω /km

Mechanical and chemical properties

Bending radius (stationary installation) $\geq 5 \times \varnothing$

Bending radius (flexible use) $\geq 10 \times \varnothing$

Ambient temperature range (stationary) -40...+105 °C

Ambient temperature range (In motion) 0...+80 °C

Accessories

TORQUE-WRENCH-SET-AS 6936170

Torque wrench set; handles with adjustable torque 0.4-1.0 Nm, torque wrench for M8 (SW9), fork wrench for M12 (SW 14)