

RKC5T-10/TXL1001

Weld-Splatter Resistant Actuator and Sensor Cable – Connection Cable

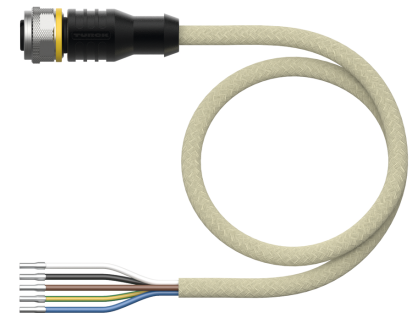
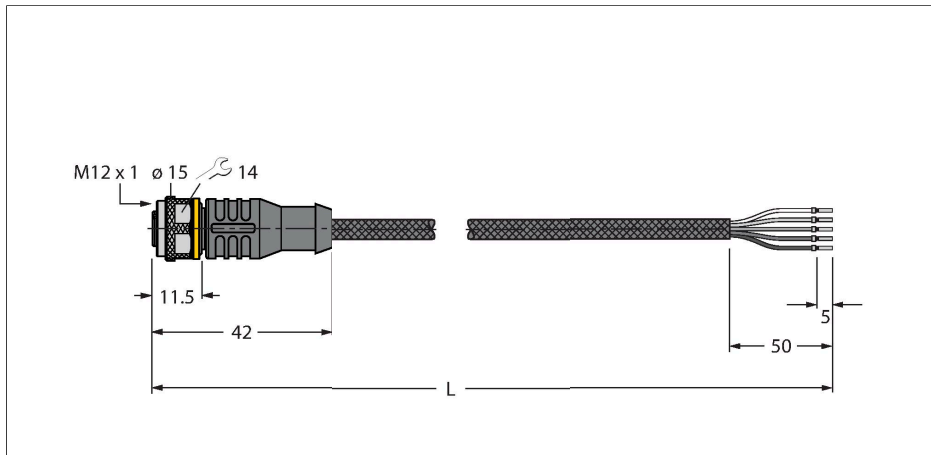

Technical data

Type	RKC5T-10/TXL1001
ID	6630229
Remark to product	!!! Pin 5 = PE !!!
Connector A	Female, M12 × 1, Straight, A-coded
Number of Pins	4+PE
Contacts	Brass, CuZn, Gold-plated
Contact carriers	Plastic, TPU, Black
Connector body	Plastic, TPU, Black
Coupling nut/screw	Brass, CuZn, Nickel-plated
Seal	Plastic, FPM/FKM
Mechanical lifespan	> 100 Mating cycles
Pollution degree	3
Protection class	IP67, IP69K, Only in screwed condition
Cable	
Cable diameter	Ø 6.1 mm ±0.20
Cable length	10 m
Cable jacket	PUR, Yellow
Core insulation	PP
Core cross-section	5 x 0.34 mm ²
Arrangement of strands	42 x 0.1 mm
Core colors	BN, WH, BU, BK, GNYE
Electrical properties at +20 °C	
Rated voltage	60 V
Test voltage	2000 V
Current	4 A
Insulation resistance	> 30.5 MΩ/km

Features



- Female M12, straight, 4-pin + PE
- Jacket material: PUR jacketed with aramid fibers
- Jacket color: yellow
- Resistant to welding sparks
- Flame retardant
- Resistant to chemicals, UV radiation and oils
- Free from halogen, silicone, PVC and LABS
- Protection class: IP67, IP69K
- Protective jacket material: aramid fibers
 - Tensile strength: 2923 MPa
 - Breaking strength: 333 N
 - Elongation at break: 3.6 %
 - Temperature peaks: up to +200 °C
- Cable length: 10 m

Cable Cross-Section

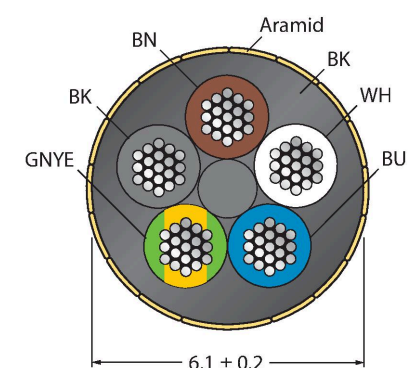

Technical data

forward resistance max. 57 Ω/km

Mechanical and chemical properties

Bending radius (stationary installation) ≥ 5 x Ø

Bending radius (flexible use) ≥ 10 x Ø

Ambient temperature range (stationary) -50...+105 °C

Ambient temperature range (In motion) -30...+90 °C

Contact assignment

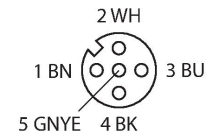

Circuit Diagram

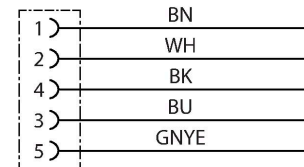

Accessories

TORQUE-WRENCH-SET-AS

6936170

Torque wrench set; handles with adjustable torque 0.4-1.0 Nm, torque wrench for M8 (SW9), fork wrench for M12 (SW 14)

BS8151-0

6904611

Field-wireable male connector, M12 × 1, straight, 5-pin, screw terminal connection, cable feedthrough 4.0 to 6.0 mm, core cross-section/terminal capacity 0.14 to 0.75 mm², plastic housing, metal retaining screw

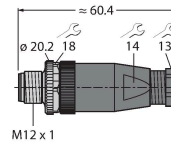

BS8251-0

6904612

Field-wireable male connector, M12 × 1, angled, 5-pin, screw terminal connection, cable feedthrough 4.0 to 6.0 mm, core cross-section/terminal capacity 0.14 to 0.75 mm², plastic housing, metal retaining screw

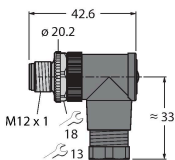

FW-ERSPM0526-SA-P-0408

100002535

Field-wireable male connector, M12 × 1, straight, 5-pin, push-in connection, cable feedthrough 4.0 to 8.0 mm, core cross-section/terminal capacity 0.14 to 0.75 mm², plastic housing, metal retaining screw

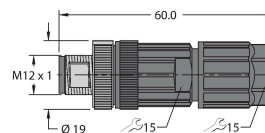

FW-ERSPM0516-SA-S-0408

100002289

Field-wireable male connector, M12 × 1, straight, 5-pin, screw terminal connection, cable feedthrough 4.0 to 8.0 mm, core cross-section/terminal capacity 0.25 to 1.5 mm², plastic housing, metal retaining screw

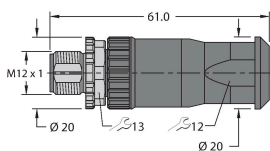

FW-EWSPM0516-SA-S-0408

100002291

Field-wireable male connector, M12 × 1, angled, 5-pin, screw terminal connection, cable feedthrough 4.0 to 8.0 mm, core cross-section/terminal capacity 0.25 to 1.5 mm², plastic housing, metal retaining screw

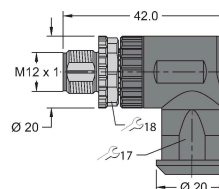

Accessories

Dimension drawing

Type

ID

LABEL-HOLDER-FLEX-PVC

100048170

PVC label holder for identification of extension cables (TEL/TXL product series); for cable diameters: min. 5 mm;

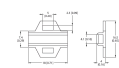

Dimension drawing	Type	ID	dimensions 4 × 18 mm; delivery unit: 50 pcs. per package
-------------------	------	----	--