

RKC8.800T-30/TEL

Actuator and Sensor Cable, PVC – Connection Cable

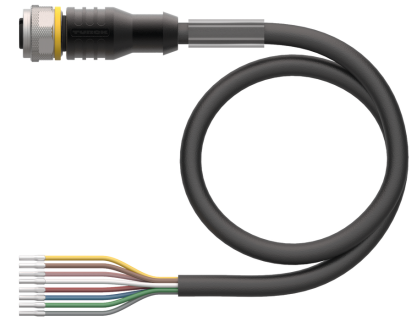
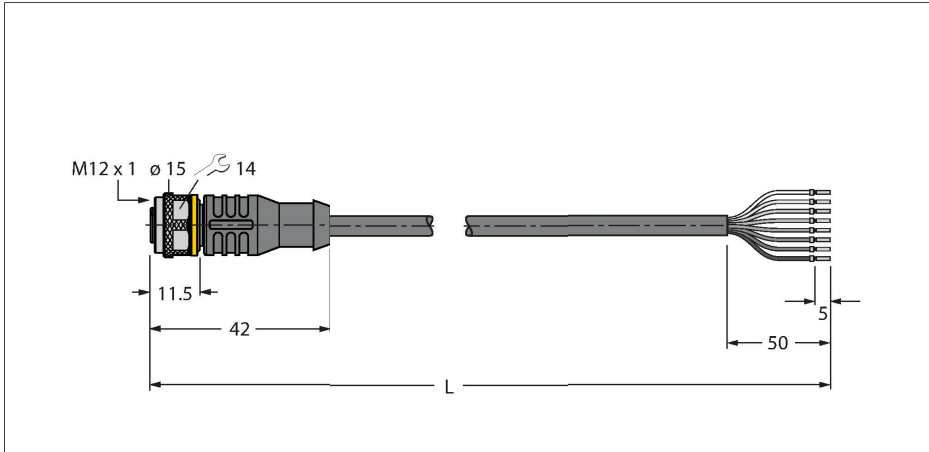

Technical data

Type	RKC8.800T-30/TEL
ID	6631555
Connector A	Female, M12 × 1, Straight, A-coded
Number of Pins	8
Contacts	Brass, CuZn, Gold-plated
Contact carriers	Plastic, TPU, Black
Connector body	Plastic, TPU, Black
Coupling nut/screw	Brass, CuZn, Nickel-plated
Seal	Plastic, FPM/FKM
Mechanical lifespan	> 100 Mating cycles
Pollution degree	3
Protection class	IP67, IP69K, Only in screwed condition
Cable	
Cable diameter	Ø 5.7 mm ±0.20
Cable length	30 m
Cable jacket	PVC, Black
Core insulation	PVC
Core cross-section	8 x 0.25 mm ²
Arrangement of strands	32 x 0.1 mm
Core colors	WH, BN, GN, YE, GY, PK, BU, RD
Electrical properties at +20 °C	
Rated voltage	30 V
Test voltage	2000 V
Current	2 A
Insulation resistance	> 30.5 MΩ/km
forward resistance	max. 79 Ω/km

Features



- Female M12, straight, 8-pin
- Jacket material: PVC
- Jacket color: black
- Resistant to chemicals and oils
- Flame retardant
- Resistant to acids and alkaline solutions
- Resistant to microbes and hydrolysis
- LABS free
- Protection class: IP67, IP69K
- Cable length: 30 m

Cable Cross-Section

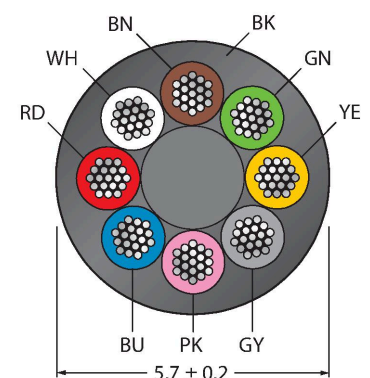

Contact assignment

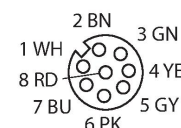

Technical data

Mechanical and chemical properties

Bending radius (stationary installation)	$\geq 5 \times \varnothing$
Bending radius (flexible use)	$\geq 10 \times \varnothing$
Ambient temperature range (stationary)	-40...+105 °C
Ambient temperature range (In motion)	-5...+80 °C
Approvals	cULus

Circuit Diagram

1)	WH
2)	BN
3)	GN
4)	YE
5)	GY
6)	PK
7)	BU
8)	RD

Accessories

TORQUE-WRENCH-SET-AS

6936170

Torque wrench set; handles with adjustable torque 0.4-1.0 Nm, torque wrench for M8 (SW9), fork wrench for M12 (SW 14)

BLANK-LABEL-FOR-CORDSETS-TEL-TXL

6936206

Label for TEL and TXL cables, length: 18 mm, height: 4 mm, material: polycarbonate (PC), color: white, halogen-free and flame-retardant

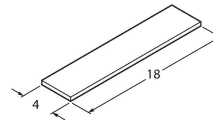

BS8181-0

6901004

Field-wireable male connector, M12 x 1, straight, 8-pin, screw terminal connection, cable feedthrough 6.0 to 8.0 mm, core cross-section/terminal capacity 0.14 to 0.50 mm², plastic housing, metal retaining screw

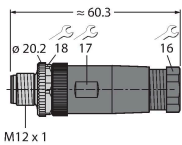

BS8281-0

6930862

Field-wireable male connector, M12 x 1, angled, 8-pin, screw terminal connection, cable feedthrough 6.0 to 8.0 mm, core cross-section/terminal capacity 0.14 to 0.50 mm², plastic housing, metal retaining screw

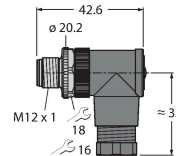

CMBS8181-0

6930792

Field-wireable male connector, M12 x 1, straight, 8-pin, screw terminal connection, cable feedthrough 6.0 to 8.0 mm, core cross-section/terminal capacity 0.14 to 0.50 mm², metal housing, metal nut, shieldable, also for Ethernet

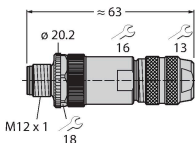

Accessories

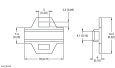
Dimension drawing	Type	ID	
	LABEL-HOLDER-FLEX-PVC	100048170	PVC label holder for identification of extension cables (TEL/TXL product series); for cable diameters: min. 5 mm; dimensions 4 x 18 mm; delivery unit: 50 pcs. per package