

Fieldbus cable for fieldbus systems according to IEC61158-2, 4-pole RKV-FBY49BU-3M/5D

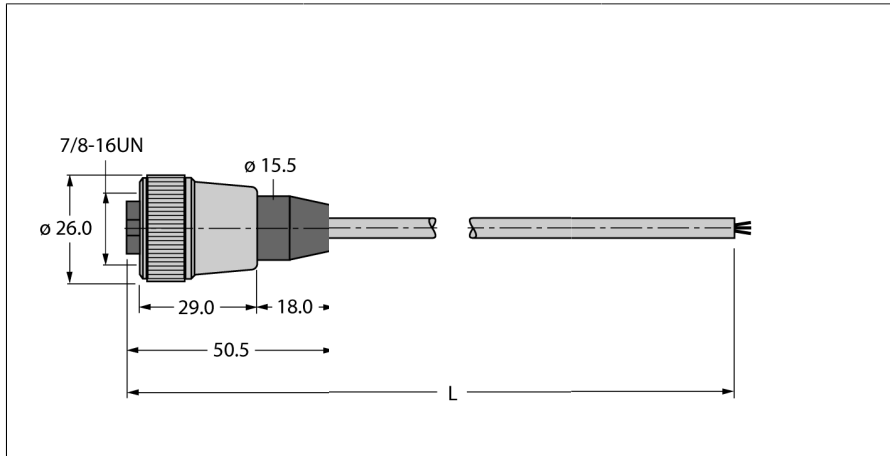

- Fieldbus cable, type A, acc.to IEC 61158-2
- PVC jacket, blue
- Oil, gas and sunlight resistant
- Temperature range -40...+75 °C
- Cable cross section: 18/7 AWG (0.8 mm²)
- Open end
- 7/8" female, straight, stainless steel
- Cable length 3 m

Cable Cross-section

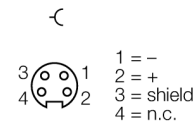

Type	RKV-FBY49BU-3M/5D
ID	8900281
Connector A	Female, 7/8"-16 UN, Straight
Number of Pins	4
Contacts	Metal, CuZn, Gold-plated
Contact carriers	Plastic, TPU, Black
Connector body	Plastic, PUR, Black
Protection class	IP67, Only in screwed condition
Cable diameter	Ø 8mm -0.30
Cable length	3 m
Cable jacket	PVC, Blue
Shielding	Plastic-covered aluminum foil, metal side outside, makes contact with drain wire and tinned copper wire
Bending radius (stationary installation)	≥ 5 x Ø
Core insulation	PE foam with PE jacket
Core colors	BN, BU
Core cross-section	2 x 0.8
DC resistance (loop)	43.6 Ω/km
Shield resistance	Nom. 9 Ω/km
Nom. impedance	100 ± 20 Ω (31.25 kBit/s)
Working capacitance	Nom. 60 nF/km
Capacitive earthing	max. 2 nF/km
Damping	max. 3.0 dB/km (with f = 39 kHz)
Skew	max. 1.7 µs/km (7.9 kHz - -39 kHz)
Nom. Inductance	0.7 mH/km
Voltage	300 V
Ambient temperature range (stationary)	-40...+75°C
Ambient temperature range (In motion)	-5...+50°C
UV resistance	Acc. to UL 1581, section 1200
Oil-resistant	according to ICEA S82-552
Flame-retardant	according to IEC 60332-3