

RKC12.120T-2/TEL

Actuator and Sensor Cable, PVC – Connection Cable

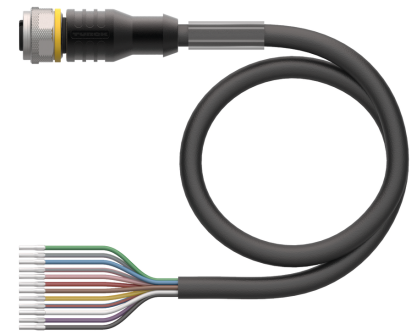
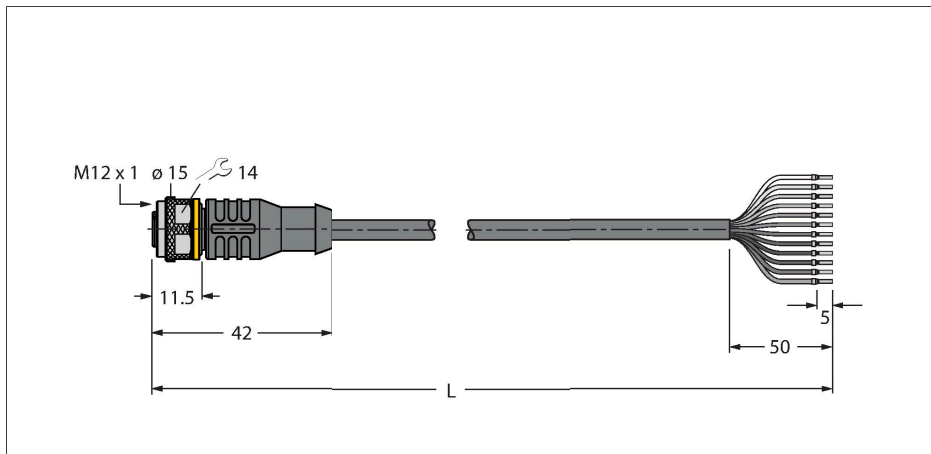

Technical data

Type	RKC12.120T-2/TEL
ID	6631464
Connector A	Female, M12 × 1, Straight, A-coded
Number of Pins	12
Contacts	Brass, CuZn, Gold-plated
Contact carriers	Plastic, TPU, Black
Connector body	Plastic, TPU, Black
Coupling nut/screw	Brass, CuZn, Nickel-plated
Seal	Plastic, FPM/FKM
Mechanical lifespan	> 100 Mating cycles
Pollution degree	3
Protection class	IP67, IP69K, Only in screwed condition
Cable	
Cable diameter	Ø 5.9 mm ±0.20
Cable length	2 m
Cable jacket	PVC, Black
Core insulation	PVC
Core cross-section	12 x 0.14 mm ²
Arrangement of strands	18 x 0.1 mm
Core colors	BN, BU, WH, GN, PK, YE, BK, GY, RD, VT, GY/PK, RD/BU
Electrical properties at +20 °C	
Rated voltage	30 V
Test voltage	2000 V
Current	1.5 A
Insulation resistance	> 30.5 MΩ/km
forward resistance	max. 138 Ω/km

Features



- Female M12, straight, 12-pin
- Jacket material: PVC
- Jacket color: black
- Resistant to chemicals and oils
- Flame retardant
- Resistant to acids and alkaline solutions
- Resistant to microbes and hydrolysis
- LABS free
- Protection class: IP67, IP69K
- Cable length: 2.0 m

Cable Cross-Section

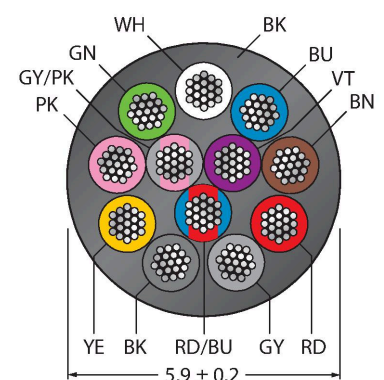

Contact assignment

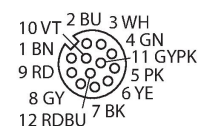

Technical data

Mechanical and chemical properties	
Bending radius (stationary installation)	$\geq 5 \times \varnothing$
Bending radius (flexible use)	$\geq 10 \times \varnothing$
Ambient temperature range (stationary)	-40...+105 °C
Ambient temperature range (In motion)	-5...+80 °C
Approvals	cULus

Circuit Diagram

1)	BN
2)	BU
3)	WH
4)	GN
5)	PK
6)	YE
7)	BK
8)	GY
9)	RD
10)	VT
11)	GY/PK
12)	RD/BU

Accessories

TORQUE-WRENCH-SET-AS	6936170
Torque wrench set; handles with adjustable torque 0.4-1.0 Nm, torque wrench for M8 (SW9), fork wrench for M12 (SW 14)	

BLANK-LABEL-FOR-CORDSETS-TEL-TXL	6936206
Label for TEL and TXL cables, length: 18 mm, height: 4 mm, material: polycarbonate (PC), color: white, halogen-free and flame-retardant	

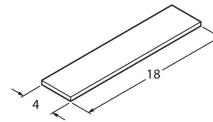

BS81121-0/PG9	6604053
Field-wireable male connector, M12 x 1, straight, 12-pin, solder contact, cable feedthrough 6.0 to 8.0 mm, core cross-section/terminal capacity 0.14 to 0.25 mm ² , plastic housing, metal retaining screw	

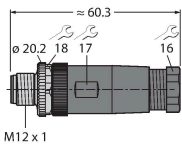

BS82121-0/PG9	6936122
Field-wireable male connector, M12 x 1, angled, 12-pin, solder contact, cable feedthrough 6.0 to 8.0 mm, core cross-section/terminal capacity 0.14 to 0.25 mm ² , plastic housing, metal retaining screw	

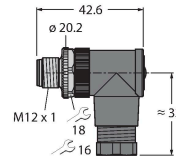

Accessories

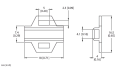
Dimension drawing	Type	ID	
	LABEL-HOLDER-FLEX-PVC	100048170	PVC label holder for identification of extension cables (TEL/TXL product series); for cable diameters: min. 5 mm; dimensions 4 x 18 mm; delivery unit: 50 pcs. per package