

M18SP6FF50QPMA

Photoelectric Sensor – Diffuse Mode Sensor with Fixed-Field Background Suppression

Technical data

Type	M18SP6FF50QPMA
ID no.	3072708
Optical data	
Function	Proximity switch
Operating mode	Background suppression, non-adjustable
Light type	IR
Wavelength	880 nm
Range	0...50 mm
Electrical data	
Operating voltage	10...30 VDC
No-load current	≤ 25 mA
Short-circuit protection	yes / Cyclic
Reverse polarity protection	yes
Output function	Connection programmable, PNP
Switching frequency	≤ 160 Hz
Readiness delay	≤ 100 ms
Response time typical	< 3 ms
Overcurrent release	> 220 mA
Mechanical data	
Design	Threaded barrel, M18
Dimensions	Ø 18 mm
Housing material	Metal, Stainless steel
Lens	plastic, Acrylic
Electrical connection	Cable with connector, M12 × 1, 0.15 m, PUR
Number of cores	4
Ambient temperature	-40...+70 °C
Protection class	IP69
Special features	Chemical-resistant Encapsulated Wash down
Power-on indication	LED, Green
Switching state	LED, Yellow
Error indication	LED, green, Flashing
Excess gain indication	LED
Alarm display	LED yellow Flashing



Features

- Cable with male end M12 × 1, 4-pin, PUR, 150 mm
- Protection class IP67
- Ambient temperature: -40 °C...+70 °C
- Metal housing
- Operating voltage: 10...30 VDC
- PNP switching output, changeover

Wiring diagram

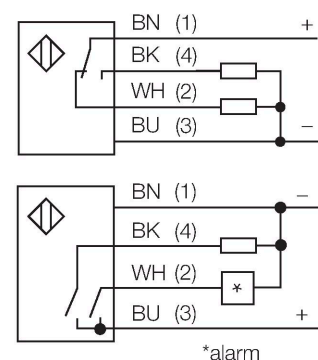

Functional principle

The emitter and receiver are incorporated in a single housing. The light reflection of the target is detected and triggers the sensor to switch. Thus the switching distance largely depends on the reflectivity of the target.

Excess gain curve

Excess gain in relation to the distance

Technical data

Tests/approvals

MTTF 448 years acc. to SN 29500 (Ed. 99) 40 °C

Approvals CE

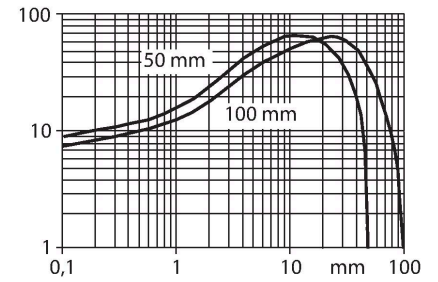

Accessories

SMB18A

3033200

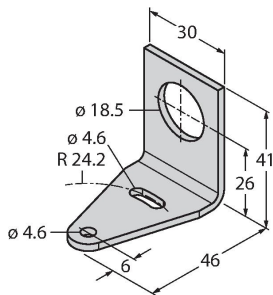

Mounting bracket, rectangular, stainless steel, for sensors with 18 mm thread

SMB18AFAM10

3012558

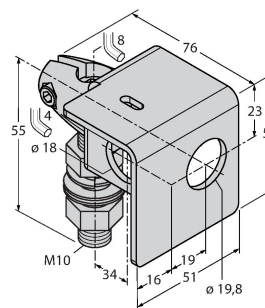

Mounting bracket, material VA 1.4401, for M10 x 1.5 thread, thread length 18 mm

SMB3018SC

3053952

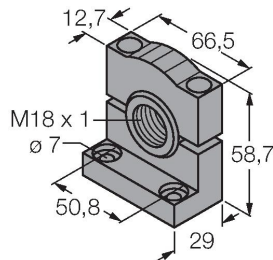

Mounting bracket, PTB black, for sensors with 18 mm thread

SMBAMS18P

3073134

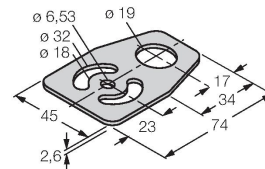

Mounting bracket, stainless steel, for sensors with 18 mm thread