

SM2A312CQD

Photoelectric Sensor – Convergent Mode Sensor

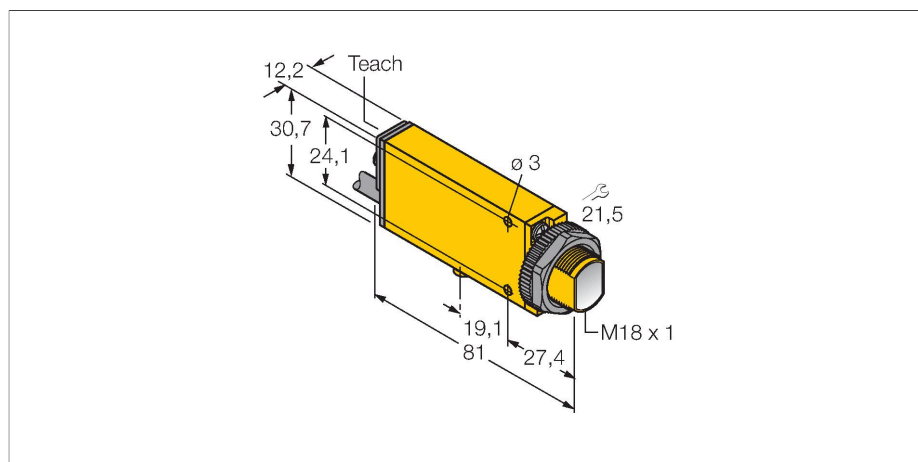

Features

- Cable, PVC, 2 m
- Protection class IP67
- Sensitivity adjustable via potentiometer
- Alignment indicator
- Operating voltage: 24...240 VAC
- Switching output, bipolar
- Light/dark operation

Wiring diagram

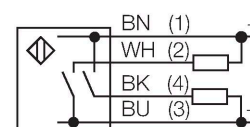

Technical data

Type	SM2A312CQD
ID no.	3033730
Optical data	
Function	Proximity switch
Operating mode	Convergent
Light type	IR
Wavelength	880 nm
Focal distance	16 mm
Range	16 mm
Electrical data	
Operating voltage	24...240 VAC
Output function	Relay output
Readiness delay	≤ 300 ms
Response time typical	< 4 ms
Setting option	Potentiometer
Mechanical data	
Design	Rectangular with thread, Mini Beam
Dimensions	Ø 18 mm
Housing material	Plastic, Thermoplastic material, Yellow
Lens	plastic, Acrylic
Electrical connection	Connectors, 1/2", PVC
Number of cores	3
Ambient temperature	-20...+70 °C
Protection class	IP67
Excess gain indication	LED
Tests/approvals	
Approvals	CE, cURus, CSA

Functional principle

Convergent mode sensors are equipped with a lens in front of the emitter diode that produces a small and intense focal point at a defined distance from the sensor. Similar to diffuse mode sensors, the light reflected by the target is evaluated. Convergent mode sensors are ideal for detection of small targets or colour marks and edge guiding or positioning control of transparent materials. The targets must always be within the focal depth of the sensors. The focal depth is defined as the area in front of or behind the focal point within which the object can be detected. Based on the intense light concentration in the focal point, convergent mode sensors are capable of detecting targets with a low reflectivity.

Excess gain curve
Excess gain in relation to the distance

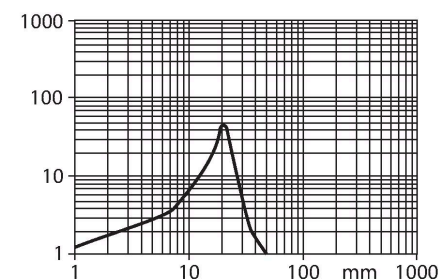

Accessories

SMB18A

3033200

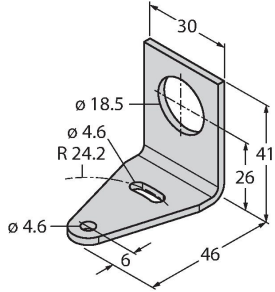

Mounting bracket, rectangular, stainless steel, for sensors with 18 mm thread

SMB18AFAM10

3012558

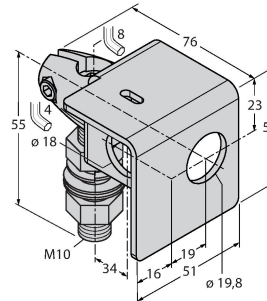

Mounting bracket, material VA 1.4401, for M10 x 1.5 thread, thread length 18 mm

SMB18SF

3052519

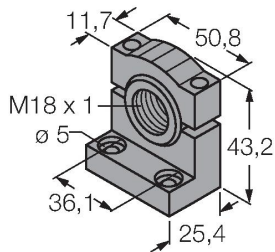

Mounting bracket, PBT black, for sensors with 18 mm thread, rotatable

SMB312B

3025519

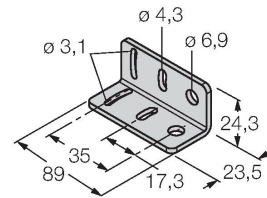

Mounting bracket, stainless steel, for MINI-BEAM NAMUR

SMB3018SC

3053952

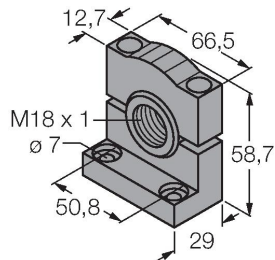

Mounting bracket, PTB black, for sensors with 18 mm thread