

RSSW-RKSW451-15M

PROFIBUS Cable – PUR Cable Jacket

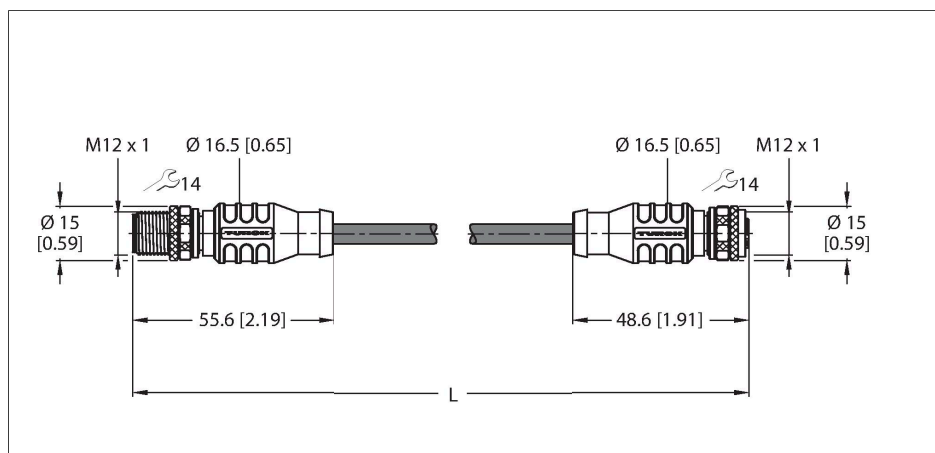

Technical data

Type	RSSW-RKSW451-15M
ID	6914123
Connector A	Male, M12 × 1, Straight, B-coded
Number of Pins	5
Contacts	Metal, CuZn, Gold-plated
Contact carriers	Plastic, TPU, Black
Connector body	Plastic, TPU, Black
Coupling nut/screw	Brass, CuZn, Nickel-plated
Tightening torque (range)	0.8 ... 1 Nm (observe max. torque of mating connector!)
Mechanical lifespan	> 100 Mating cycles
Pollution degree	3
Protection class	IP67, Only in screwed condition
Connector B	Female, M12 × 1, Straight, B-coded
Number of pins	5
Contacts	Metal, CuZn, Gold-plated
Contact carriers	Plastic, TPU, Black
Connector body	Plastic, PUR, Black
Coupling nut/retaining screw	Brass, CuZn, Nickel-plated
Seal	Plastic, FPM/FKM
Tightening torque	0.8 ... 1 Nm (observe max. torque of mating connector!)
Mechanical life	> 100 Mating cycles
Pollution degree	3
Protection class	IP67, Only when screwed together
Cable	
Network protocol	PROFIBUS-DP, 451

Features



- PROFIBUS cable: 2 × 0.34 mm²
- Jacket material: PUR, color: purple
- Jacket diameter: 8.2 mm
- Suitable for drag chain use
- Resistant to chemicals, UV radiation and oils
- Flame retardant acc. to DIN EN 60332-2-2, VDE 0482-332-2-2, IEC 60332-2-2, CSA FT-2
- Halogen free acc. to DIN EN 50267-2-1, VDE 0482-267-2-1, IEC 60754-1
- Free from silicone, PVC and LABS
- Resistant to microbes and hydrolysis
- RoHS compliant
- UL approved
- M12 female, straight, reverse-keyed
- Cable length: 15 m

Cable Cross-Section

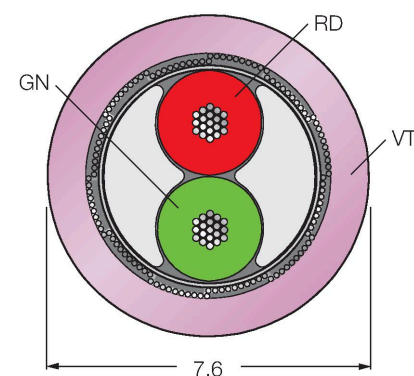

Technical data

Cable diameter	Ø 8.2 mm +0.30
Cable length	15 m
Cable jacket	PUR, Violet
Shielding	Aluminum foil, tinned copper wire
Core insulation	PE
Core cross-section	2 x 0.34 mm ²
Arrangement of strands	19 x 0.15 mm
Core colors	GN, RD
Electrical properties at +20 °C	
Rated voltage	60 V
Test voltage	2000 V
Current	4 A
DC resistance (loop)	110 Ω/km
Nom. impedance	160 Ω (16 MHz)
Nom. capacitance	28 pF/m
Nom. Inductance	0.78 mH/km
Damping	< 43.60 dB/km at 16.0 MHz
Mechanical and chemical properties	
Max. tensile strength (static)	≤ 50 N/mm ²
Max. tensile strength (dynamic)	≤ 20 N/mm ²
Bending radius (stationary installation)	≥ 5 x Ø
Bending radius (flexible use)	≥ 10 x Ø
Bending cycles	≥ 3 million
Admissible acceleration	max. 5 m/s ²
Admissible travel path, horizontal	5 m (at 5 m/s ²)
Admissible travel path, vertical	2 m (at 5 m/s ²)
Admissible traversing speed	3.33 m/s
Ambient temperature range (stationary)	-50...+80 °C
Ambient temperature range (In motion)	-25...+80 °C
Ambient temperature during drag chain operation	-25...+60 °C
Other Features	
Qualified for drag chain use	yes
Halogen-free	yes
Silicone-free	yes
LABS free	yes
PVC-free	yes
Resistant to chemicals	yes
UV resistance	yes
Oil-resistant	yes
Flame-retardant	yes

Circuit Diagram

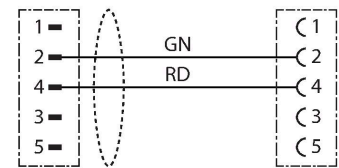

Technical data

Approvals

UL
