

# LTX1250M-F10-LI0-X3-H1151

## Pressure-Resistant Linear Position Sensor – Analog



### Technical data

Type	LTX1250M-F10-LI0-X3-H1151
ID	1540306
Remark to product	Please note housing design on page 2
Measuring principle	Magnetostrictive
<b>General data</b>	
Measuring range	1250 mm
Resolution	16 bit
Blind zone a	50.8 mm
Blind zone b	63.5 mm
Repeat accuracy	≤ 0.01 % of full scale
Linearity deviation	≤ 0.01 % f.s.
Hysteresis	≤ 0.025 mm
<b>Electrical data</b>	
Operating voltage	7...30 VDC
Residual ripple	≤ 10 % U <sub>ss</sub>
Short-circuit protection	yes / Cyclic
Wire breakage/Reverse polarity protection	yes (voltage supply)
Output function	5-pin, Analog output, Differential or common ground (see manual)
Current output	4...20 mA
Load resistance current output	≤ 0.5 kΩ
Current consumption	< 60 mA at 24 VDC
<b>Mechanical data</b>	
Design	Rod
Dimensions	1445.6 mm
Housing material	Metal, AL
Active area material	Stainless steel, 1.4404 (AISI 316L)

### Features

- Suited for hydraulic cylinders
- The sensor is pressure resistant up to 340 bar (permanent), 680 bar (short-term)
- Shock-proof up to 100g
- Status displayed via 3 color LED
- 16-bit resolution
- Adjustable measuring range
- Operating temperature rod -40 °C...+105 °C
- Operating temperature electronics -40 °C...+85 °C
- Protection class IP68
- 7...30 VDC supply voltage
- Analog output 4...20 mA
- M12 × 1 connector

### Wiring diagram

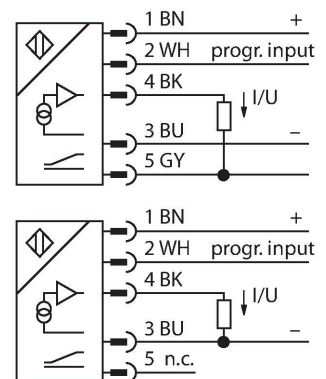

### Functional principle

The LTX is a magnetostrictive sensor, optimized for precise position control in hydraulic cylinders. With the assistance of optional floats, the magnetically actuated position sensors also implement additional fill level monitoring. The absolute value sensor is very robust and precise, and also saves the position

## Technical data

Electrical connection	Connector, M12 × 1
<b>Environmental conditions</b>	
Ambient temperature	-40...+85 °C
Vibration resistance	30 Hz (1 mm)
Shock resistance	100 g (11 ms)
Protection class	IP68
Measuring range display	multifunction LED

information in the event of a voltage failure, so that additional zeroing is unnecessary. The sensors operate on the contactless function principle and are thus wear and maintenance free.

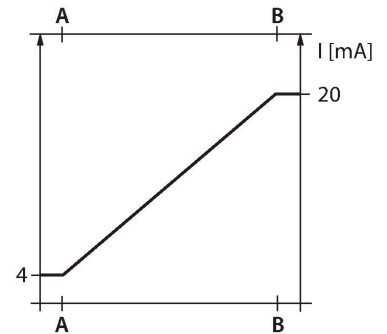

## Mounting instructions

### Mounting instructions/Description

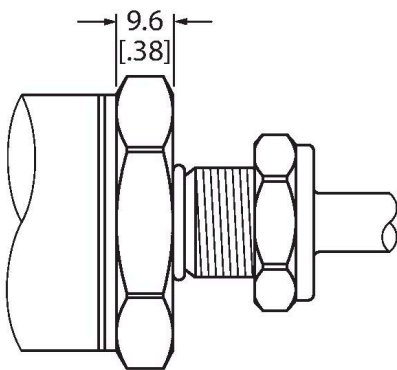

### Flat Face Design

This sensor comes in flat face design (see drawing).

To fasten the sensor, the end cap of the hydraulic cylinder must have an M18 × 1.5 threaded bore according to ISO 6149-1. For more information, refer to the operating instructions.

## Accessories

CM-R10

6900416

Standard positioning element, suitable for mounting in hydraulic cylinders



STM-AL-R10

6900409

Standard 4-hole positioning element, material: Aluminum



## LSPM-AL-R10

6900414



Ring-type positioning element with slot, can be used for external mounting with mounting bracket RB-R10, material: Aluminum

## EF-R10

6900417



Float-type positioning element, specific weight 0.62 kg/m<sup>3</sup>, suitable for external mounting for level monitoring, material: Stainless steel

## STS-R10

6900411

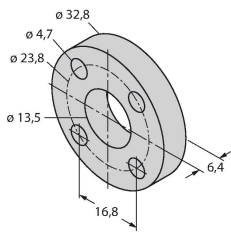

Standard spacer made of non-ferrous material for separating the positioning element from the base of the hydraulic piston rod

## MB-R10

6900419

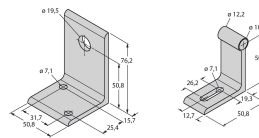

Mounting bracket for sensor head and rod, for external mounting

## RB-R10

6900420

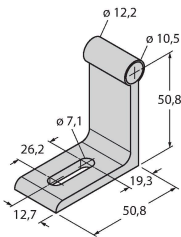

Mounting bracket for rod, for external mounting

## MMB-R10

6900004

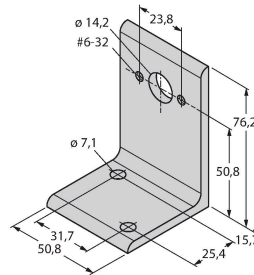

Mounting bracket for positioning element, for external mounting

## RP-Q21

6900005

Teach adapter to adjust the measuring range

Kein Maßbild vorhanden/  
No dimension drawing available