

Profibus-DPV1 Set in IP20 TI-BL20-DPV1-4

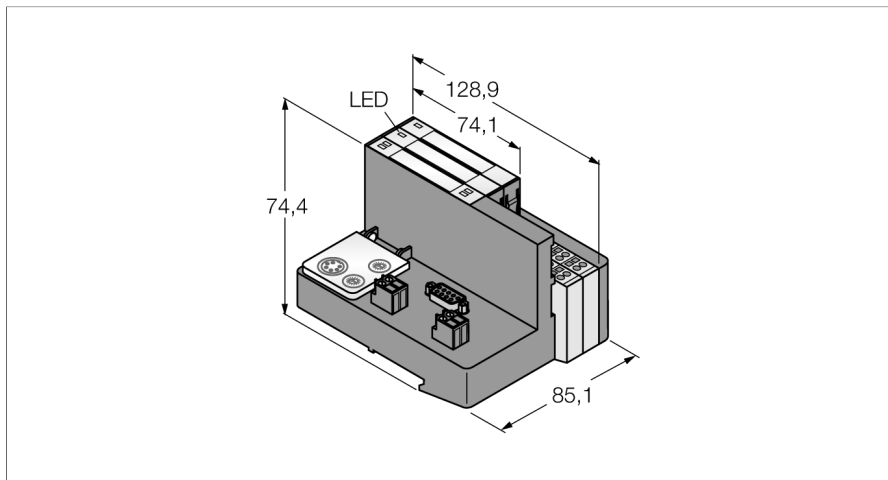

- Cable max. 50 m between interface and read/write head
- 2 decimal rotary coding switches for the adjustment of the Profibus address
- Maximum transmission rate to the fieldbus 12 Mbps
- Sub-D female, 9-pin, for fieldbus connection
- Screw terminals for voltage supply
- LEDs for display of supply voltage, group and bus errors as well as status and diagnostics
- Connection of up to 4 read/write heads via BL ident extension cables
- Mixed operation of HF and UHF read/write heads

Field/System Supply

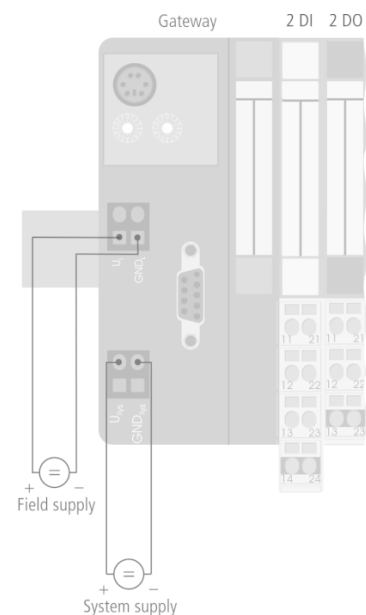

Functional principle

Pin configuration i.e. signal assignment results from the combination with an electronic module. You find the pin configuration and the wiring diagrams on the data sheet of the corresponding electronic module.

The base modules are connected to the field devices via screw connections or tension spring connections.

Note

Further technical data, like for example the temperature range, are determined by the electronic modules and can be found on the data sheets.

Type designation	TI-BL20-DPV1-4
Ident no.	1545005
Number of channels	4
Dimensions (W x L x H)	85.1 x 128.9 x 74.4 mm
Rated voltage from the supply terminal	24 VDC
Supply voltage	24 VDC
System power supply	24 VDC / 5 VDC
Field supply	24 VDC
Admissible range	18...30 VDC
Max. field supply current	10
Max. system supply current	1.2
Fieldbus transmission rate	9.6 kbps ... 12 Mbps
Fieldbus address range	1...99
Fieldbus addressing	2 rotary switches
Service interface	PS/2 socket
Fieldbus connection technology	1 x female sub-D connector
Voltage supply connection	Screw terminals
Fieldbus termination	External
Transmission rate	115.2 kbps
Electrical isolation	Electronics and field level isolated via opto-couplers
Output connectivity	Screw, tension spring
Sensor supply	0.25 A per channel, short-circuit proof
Number of diagnostics bytes	4
Number of diagnostics bytes	3
Number of parameter bytes	8
Number of parameter bytes	5
Number of input bytes	4
Number of output bytes	4
Relative humidity	15...95 %, no condensation allowed
Vibration test	Acc. to EN 61131
Shock test	Acc. to IEC 60068-2-27
Drop and topple	acc. to IEC 68-2-31 and free fall to IEC 68-2-32
Electromagnetic compatibility	Acc. to EN 50082-2
Protection class	IP20
Included in delivery	2 x end brackets BL20-WEW-35/2-SW, 1 x end plate BL20-ABPL

Profibus-DPV1 Set in IP20 TI-BL20-DPV1-4

BL20 electronic modules are plugged into the purely passive base modules which are used for connection of field devices. Maintenance is significantly facilitated due to separation of the connection level from the module electronics. Furthermore flexibility is enhanced because the base modules provide a choice of tension spring or screw connection technology.



The electronic modules are completely independent of the type of higher level field bus through the use of gateways.

BL20 gateways are the head component of a BL20 station. They are designed to interface the modular fieldbus nodes to the higher level fieldbus (PROFIBUS-DP, DeviceNet, CANopen, Ethernet).

All BL20 electronic modules communicate over the internal module bus, the data of which is transferred to the fieldbus via the gateway, so that all I/O modules can be configured independently of the bus system.

**Profibus-DPV1 Set in IP20
TI-BL20-DPV1-4**

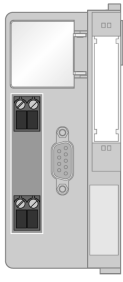
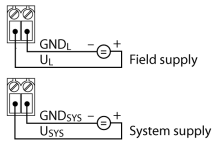
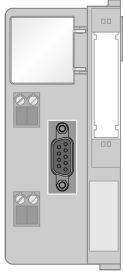
Anschlussübersicht

	<p>Power Supply The U_{SYS} system supply feeds power to the gateway and the I/O modules. The U_{L} field supply feeds power to the sensors and actuators.</p>	<p>Pin Assignment</p> 
	<p>PROFIBUS-DP Fieldbus cable (example): D9T451-2M (ident no. 6915759) or RSSW-D9T451-2M (ident no. 6915779)</p>	<p>Pin Assignment</p>  <ul style="list-style-type: none"> 1 = shield 2 = n.c. 3 = RD (Bus B) 4 = n.c. 5 = GND 6 = 5 VDC 7 = n.c. 8 = GN (Bus A) 9 = n.c.

Profibus-DPV1 Set in IP20 TI-BL20-DPV1-4

Compatible base modules

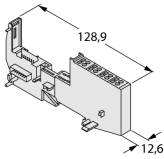
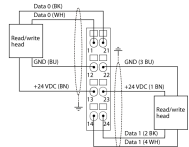
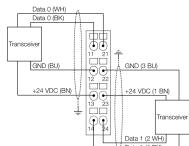
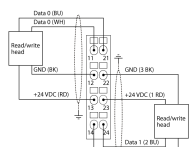
Dimension drawing	Type	Pin configuration
	<p>BL20-S4T-SBBS 6827046 Tension spring connection</p>	<p>Pin configuration .../S2500 Connectors</p> 
	<p>BL20-S4S-SBBS 6827047 Screw connection</p>	<p>.../S2501 Connectors</p> 
		<p>Connectors .../S2503</p> 

Profibus-DPV1 Set in IP20 TI-BL20-DPV1-4

LED Displays

LED	Color	Status	Meaning
D		OFF	No error message or diagnostics active.
	RED	ON	Failure of module bus communication. Check if more than two adjacent electronic modules are pulled. Relevant modules are located between the gateway and this module.
	RED	FLASHING (0.5 Hz)	Pending module diagnostics.
RW0/RW1		OFF	No tag, no active diagnostics
	GREEN	ON	Tag available
	GREEN	FLASHING (2 Hz)	Data exchange with tag enabled
	RED	ON	Read/write head error
	RED	FLASHING (2 Hz)	Short-circuit in the supply line of read/write head

Profibus-DPV1 Set in IP20
TI-BL20-DPV1-4

Accessories

Type code	Ident no.		Dimension drawing
ZBW5-2BETÄTIGUNGS	WERKZEUG	Tension spring tool	