

RSSD-4414-15M

Industrial Ethernet Cable – Connection Cable

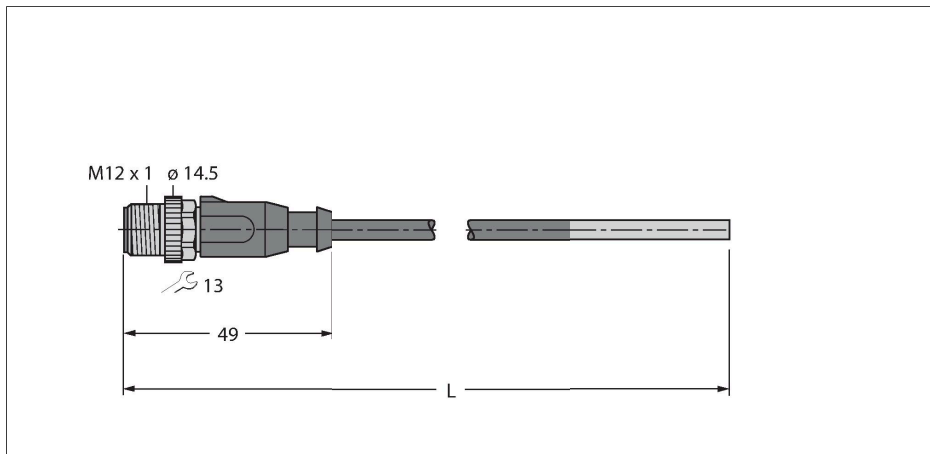

Technical data

Type	RSSD-4414-15M
ID	6935270
Connector A	Male, M12 × 1, Straight, D-coded
Number of Pins	4
Contacts	Metal, CuZn, Gold-plated
Contact carriers	Plastic, PA, UL 94, Black
Connector body	Plastic, TPU, UL 94, Black
Coupling nut/screw	Brass, GD-Zn, Nickel-plated
Tightening torque (range)	0.4 ... 0.6 Nm (observe max. torque of mating connector!)
Mechanical lifespan	> 100 Mating cycles
Pollution degree	3/2
Protection class	IP67, Only in screwed condition
Cable	
Network protocol	Ethernet, 4414
Cable diameter	Ø 4.8 mm ±0.30
Cable length	15 m
Cable jacket	PUR, Green
Shielding	Aluminum foil, tinned copper wire
Core insulation	PP
Core cross-section	4 x 0.15 mm ²
Arrangement of strands	19 x 0.102 mm
Core colors	WHOG, WHBU, BU, OG
Electrical properties at +20 °C	
Rated voltage	42 V
Test voltage	700 V
Current	3 A

Features



- M12 male connector, straight, D-coded
- End open
- Ethernet cable: 4-pin, AWG 26
- CAT 5E acc. to ISO/IEC 11801, EN 50173, EIA/TIA 568-A
- Jacket material: PUR
- Jacket color: green
- Shielding: Aluminum-laminated polyester film, copper braid
- Jacket diameter: 4.8 mm
- Suitable for drag chain use
- UV resistant
- Oil resistant acc. to IEC 60811-2-1 and DIN VDE 0282 part 10
- Free from silicone, PVC and LABS
- Free from halogen acc. to IEC 60754-2
- Flame retardant acc. to IEC 60332-1-2
- Approval: cULus
- RoHS compliant
- Protection class IP67
- Cable length: 15 m

Cable Cross-Section

Technical data

Nom. impedance	100 Ω (1MHZ)
Nom. capacitance	51 pF/m
Mechanical and chemical properties	
Bending radius (stationary installation)	≥ 15 x Ø
Bending cycles	≥ 5 million
Torsional stress	± 30 °/m
Torsion cycles	≤ 100,000 Cycles
Ambient temperature range (stationary)	-40...+80 °C
Ambient temperature range (In motion)	-25...+80 °C
Other Features	
Qualified for drag chain use	yes
Halogen-free	yes
Silicone-free	yes
PVC-free	yes
Resistant to weld splatter	yes
Resistant to chemicals	yes
UV resistance	yes
Oil-resistant	yes
Flame-retardant	yes
Approvals	cULus

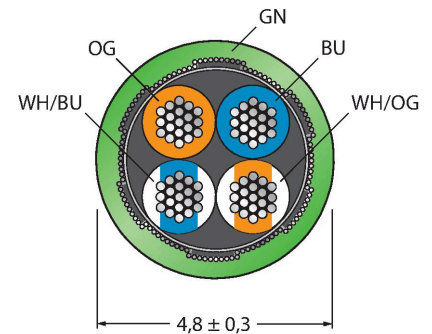

Contact assignment

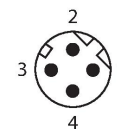

Circuit Diagram

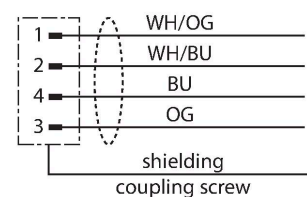

Accessories

TORQUE-WRENCH-SET-BUS	6936171
Torque wrench set; grip with adjustable torque 0.4 to 1.0 Nm; torque wrench set, fork wrench for M8 (SW9), fork wrench for M12 (SW13), fork wrench for M12 (SW14)	

Accessories

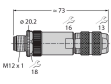
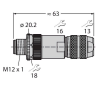
Dimension drawing	Type	ID	
	FW-M12ST5D-G-SB-ME-SH-8	6604218	Field-wireable male connector, M12 × 1, straight, 4-pin, screw terminal connection, cable feedthrough 5.0 to 8 mm, core cross-section/terminal capacity 0.14 to 0.75 mm ² , metal housing, metal coupling nut, shieldable, D-coded, for Ethernet
	CMBSD8141-0/PG9	6604282	Field-wireable male connector, M12 × 1, straight, 4-pin, screw terminal connection, cable feedthrough 6.0 to 8 mm, core cross-section/terminal capacity 0.14 to 0.75 mm ² , metal housing, metal nut, shieldable, D-coded, for Ethernet

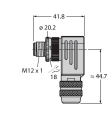
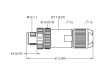
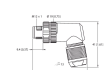
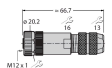
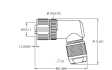
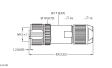
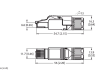
Dimension drawing	Type	ID	
	CMBSD8241-0/PG9	6604239	Field-wireable male connector, M12 × 1, angled, 4-pin, screw terminal connection, cable feedthrough 6.0 to 8 mm, core cross-section/terminal capacity 0.14 to 0.75 mm ² , metal housing, metal nut, shieldable, D-coded, for Ethernet
	FW-ERSSM0426-FD-P-0408	100033307	Field-wireable male connector, M12 × 1, straight, 4-pin, shieldable, D-coded, push-in connection, cable feedthrough 4.0 to 8.0 mm, core cross-section/terminal capacity 0.14 to 0.75 mm ² , metal housing, metal coupling nut; PROFINET CAT5 (100 Mbps)
			
	FW-EWSSM0426-FD-P-0408	100033310	Field-wireable male connector, M12 × 1, angled, 4-pin, shieldable, D-coded, push-in connection, cable feedthrough 4.0 to 8.0 mm, core cross-section/terminal capacity 0.14 to 0.75 mm ² , metal housing, metal coupling nut; PROFINET CAT5 (100 Mbps)
			
	FW-M12KU5D-G-SB-ME-SH-8	6604219	Field-wireable female connector, M12 × 1, straight, 4-pin, screw terminal connection, cable feedthrough 5.0 to 8 mm, core cross-section/terminal capacity 0.14 to 0.75 mm ² , metal housing, metal nut, shieldable, D-coded, for Ethernet
			
	FW-EWKSM0426-FD-P-0408	100033308	Field-wireable female connector, M12 × 1, angled, 4-pin, shieldable, D-coded, push-in connection, cable feedthrough 4.0 to 8.0 mm, core cross-section/terminal capacity 0.14 to 0.75 mm ² , metal housing, metal coupling nut; PROFINET CAT5 (100 Mbit/s)
			
	FW-ERKSM0426-FD-P-0408	100033304	Field-wireable female connector, M12 × 1, straight, 4-pin, shieldable, D-coded, push-in connection, cable feedthrough 4.0 to 8.0 mm, core cross-section/terminal capacity 0.14 to 0.75 mm ² , metal housing, metal coupling nut; PROFINET CAT5 (100 Mbit/s)
			
	FW-RRSSP0822-IE-I-0510	100034569	Field-wireable male connector, RJ45, straight, 8-pin, IDC connection, cable feedthrough 5.5 mm to 10.0 mm, core cross-section/terminal capacity 0.14 mm ² to 0.34 mm ² , metal housing; CAT6A (10 Gigabit Ethernet acc. to IEEE 802.3an)
			
	FW-RWSSP0822-IE-I-0510	100034570	Field-wireable male connector, RJ45, angled, 8-pin, IDC connection, cable feedthrough 5.5 mm to 10.0 mm, core cross-section/terminal capacity 0.14 mm ² to 0.34 mm ² , metal housing; CAT6A (10 Gigabit Ethernet acc. to IEEE 802.3an)
